

Este es el producto que ha comprado!  
This is the product you have purchased!  
Esse é o produto que você adquiriu!  
Voici le produit que vous avez acheté!

**Ref. 1278**

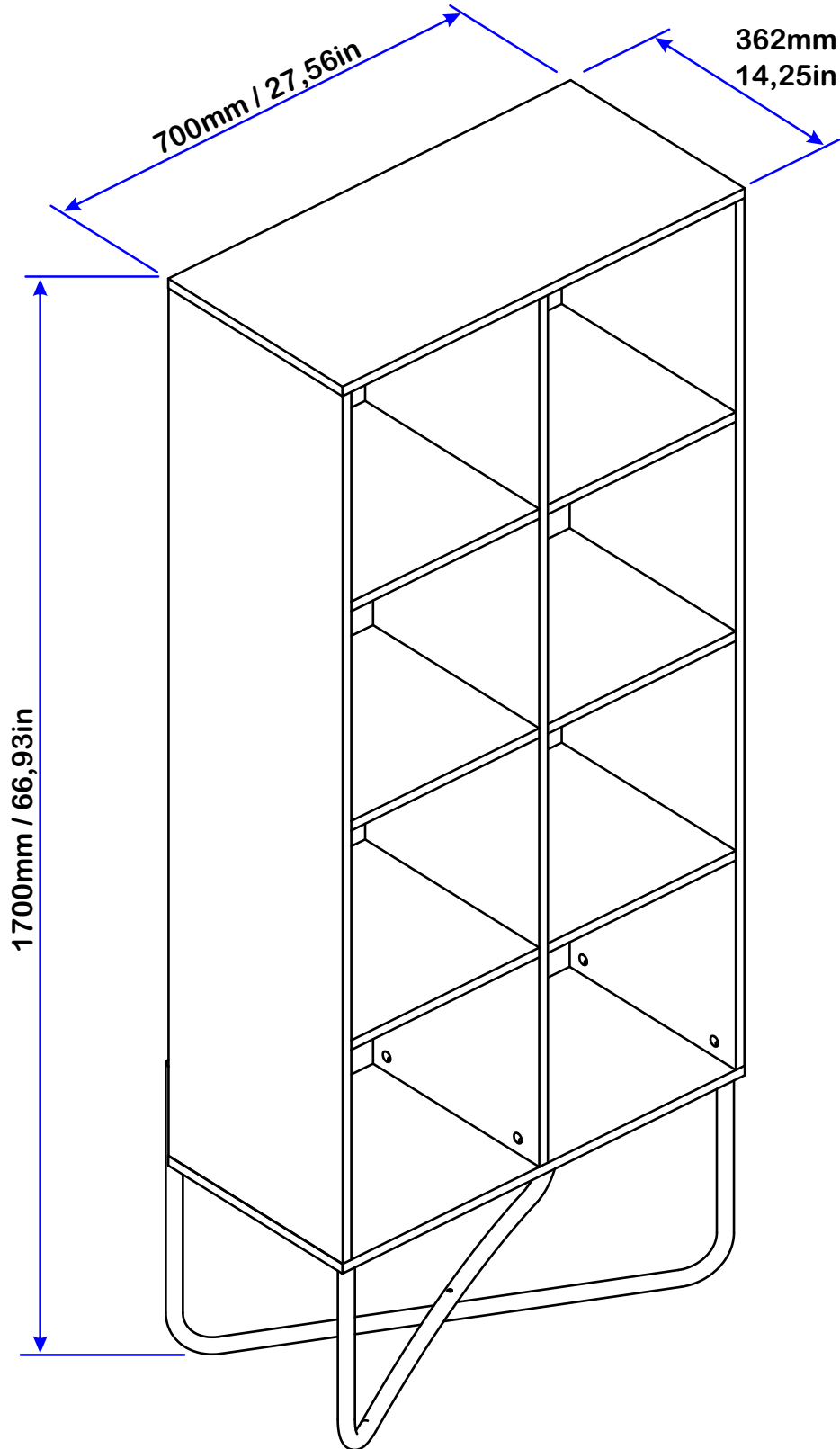

**RECOMENDACIONES PARA EL USO Y CUIDADO DEL PRODUCTO**  
**RECOMMENDATIONS FOR THE USE AND CARE OF THE PRODUCT**  
**RECOMENDAÇÕES DE USO E CUIDADOS COM O PRODUTO**  
**RECOMMANDATIONS POUR L'UTILISATION ET L'ENTRETIEN DU PRODUIT**



Lea cuidadosamente el manual y siga en el orden indicado las instrucciones de ensamble.  
 Read the manual carefully and follow the assembly instructions in the order listed.  
 Leia o manual com atenção e siga as instruções de montagem na ordem listada.  
 Lisez attentivement le manuel et suivez les instructions de montage dans l'ordre indiqué.



Ubica tus productos en una superficie lisa y plana. Utilice una protección entre el mueble y el piso.  
 Place your products on a smooth, flat surface. Use a protection between the furniture and the floor.  
 Coloque seus produtos em uma superfície lisa e plana. Use uma proteção entre a mobília e o chão.  
 Placez vos produits sur une surface lisse et plane. Utilisez une protection entre le meuble et le sol.



No pinte ni use elementos abrasivos para limpiar el mueble.  
 Do not paint or use abrasive items to clean the furniture.  
 Não pinte ou use itens abrasivos para limpar o móvel.  
 Ne pas peindre ni utiliser d'objets abrasifs pour nettoyer l'armoire.

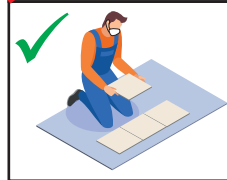

No exponga el mueble al calor ni a la humedad.  
 Do not expose the furniture to heat or humidity.  
 Não exponha a mobília ao calor ou umidade.  
 N'exposez pas le meuble à la chaleur ou à l'humidité.

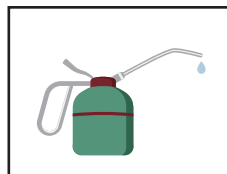

Se recomienda lubricar cada 3 meses rieles, correderas, bisagras y rodachinas.  
 It is recommended to lubricate the rails, runners, hinges and castors every 3 months.  
 Recomenda-se a lubrificação de trilhos, corredeiras, dobradiças e rodízios a cada 3 meses.  
 Il est recommandé de lubrifier les rails, glissières, charnières et roulettes tous les 3 mois.



- No arraste el mueble, esto puede causar daños en las piezas.  
 - Para desplazar el mueble asegúrese de moverlo cuando este vacío sin objetos.  
 - Siempre solicite ayuda a otra persona para moverlo.  
 - Do not drag the furniture, this can cause damage to the pieces.  
 - To move the furniture be sure to move it when it is empty without objects.  
 - Always ask someone else to help you move it.  
 - Não arraste o móvel, pois isso pode causar danos às peças.  
 - Para mover o móvel certifique-se de movê-lo quando estiver vazio e sem objetos.  
 - Sempre peça a outra pessoa para ajudá-lo a movê-lo.  
 - Ne traînez pas le meuble, cela peut endommager les pièces.  
 - Pour déplacer le meuble veillez à le déplacer lorsqu'il est vide sans objets.  
 - Demandez toujours à quelqu'un d'autre de vous aider à le déplacer.



No utilizar las gavetas como escaleras ni permitir que los niños se cuelguen de las puertas.  
 Do not use drawers as ladders or allow children to hang from doors.  
 Não use gavetas como escadas, nem permita que crianças se pendurem nas portas.  
 N'utilisez pas les tiroirs comme échelles et ne laissez pas les enfants se suspendre aux portes.



- Para mover el mueble certifique-se de movê-lo quando estiver vazio e sem objetos.  
 - Sempre peça a outra pessoa para ajudá-lo a movê-lo.  
 - Ne traînez pas le meuble, cela peut endommager les pièces.  
 - Pour déplacer le meuble veillez à le déplacer lorsqu'il est vide sans objets.  
 - Demandez toujours à quelqu'un d'autre de vous aider à le déplacer.



Evita que el trapeador o elementos similares entren en contacto con tus muebles ya que esto puede deteriorarlos.  
 Avoid that the mop or similar elements come into contact with your furniture as this can deteriorate them.  
 Evite que a esfregona ou elementos semelhantes entrem em contacto com os seus móveis, pois pode deteriorá-los.  
 Évitez que la serpillière ou des éléments similaires entrent en contact avec vos meubles car cela peut les détériorer.



Limpia regularmente la madera con un paño de microfibra para que no se acumule el polvo y así evitar que el mueble pierda su brillo.  
 Regularly clean the wood with a microfiber cloth so that dust does not accumulate and thus prevent the furniture from losing its shine.  
 Limpe regularmente a madeira com um pano de microfibra para que o pó não se acumule e evite que o móvel perca o brilho.  
 Nettoyez régulièrement le bois avec un chiffon microfibre afin que la poussière ne s'accumule pas et ainsi éviter que le meuble ne perde de son éclat.



Mantén alejado objetos puntiagudos como tijeras, llaves o cuchillos. Éstos pueden causar cortes y/o rayones.  
 Keep sharp objects like scissors, keys, or knives away. These can cause cuts and / or scratches.  
 Mantenha objetos pontiagudos como tesouras, chaves ou facas longe. Isso pode causar cortes e / ou arranhões.  
 Gardez les objets pointus comme des ciseaux, des clés ou des couteaux à distance. Ceux-ci peuvent provoquer des coupures et/ou des rayures.



No utilice papel periódico para brillar vidrios y/o espejos, esto los puede rayar. Es recomendable utilizar paños que no dejen pelusa.  
 Do not use newspaper to shine glass and / or mirrors, this can scratch them. It is recommended to use lint-free cloths.  
 Não use jornal para lusturar vidros e / ou espelhos, pois podem riscá-los. É aconselhável usar panos sem fiapos.  
 N'utilisez pas de papier journal pour faire briller le verre et/ou les miroirs, cela peut les rayer. Il est conseillé d'utiliser des chiffons non pelucheux.

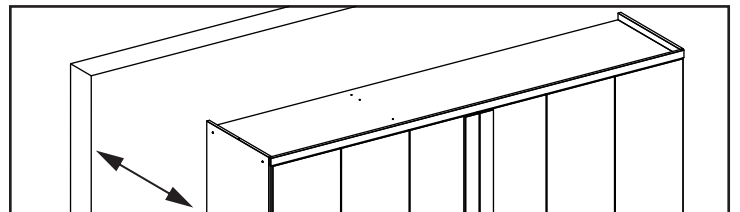

Se recomienda separar de la pared tus productos para que estos puedan tener una circulación de aire natural.

It is recommended to separate your products from the wall so that they can have a natural air circulation.

Recomenda-se separar seus produtos da parede para que tenham uma circulação natural de ar.  
 Il est recommandé de séparer vos produits du mur afin qu'ils puissent avoir une circulation d'air naturelle.



Evita que el agua entre en contacto con las partes de metal, ya que puede provocar manchas y óxido.  
 Avoid getting water on metal parts as it can cause stains and rust.  
 Evite molhar as peças de metal, pois pode causar manchas e ferrugem.  
 Évitez de mettre de l'eau sur les pièces métalliques car cela peut causer des taches et de la rouille.

# Consejos de Conservación y Pesos soportados

## Conservation Tips and Supported Weights

### Dicas de Conservação e Pesos Suportados

### Conseils d'entretien et Poids Supportés

**ES:** 1. No debe utilizarse en la limpieza, abrasivos como lana de acero, alcohol, limón, o productos corrosivos que puedan rayar o quitar la película en los muebles.

2. Cuando la limpieza de muebles en general, napa y formica, deben utilizarse un paño ligeramente humedecido y jabón suave.
3. Para mover el mueble, es importante que este se eleve desde el suelo, debido a que el arrastre puede causar daño estructural.
4. No deje el mueble en exposición a la intemperie.

**EN:** 1. Do not use abrasive products to clean such as steel wool, alcohol, vinegar, lemon, scouring powder, or corrosive products which can scratch or peel off the protective film of the furniture.

2. The best way to clean your furniture is to use a slightly moistened cloth with a mild soap.
3. To move the furniture assembled, it is important that it is lifted off the ground, because the drag it can cause structural damage.
4. Do not leave your furniture in weather exposure.

**PT:** 1. Não utilizar na limpeza produtos abrasivos tais como: palha de aço, álcool, vinagre, limão, saponáceo ou produtos corrosivos que possam riscar ou descolar a película protetora dos móveis.

2. Na limpeza de móveis em geral, napas e fórmicas, deve ser utilizado um pano levemente umedecido e sabão neutro.
3. Para a movimentação do móvel, é importante que este seja levantado do chão, pois ao arrastá-lo pode causar avarias estruturais.
4. Não deixe o móvel em exposição a intempéries.

**FR:** 1. Ne pas utiliser de produits abrasifs dans le nettoyage, tels que: laine d'acier, alcool, vinaigre, citron, poudre à récurer ou d'autres produits corrosifs pouvant rayer ou faire décoller la pellicule protectrice des meubles.

2. Pour le nettoyage du meuble, il est recommandé d'utiliser un chiffon humide et du savon neutre.
3. Pour déplacer le meuble, il est important de le soulever du sol car le tirer pourrait causer des dommages dans sa structure.
4. Ne pas exposer le meuble aux intempéries.

**ES:** Por favor, preste atención a los pesos máximos admitidos por cada compartimento del producto. Tenga cuidado de no exceder estos pesos, con el fin de garantizar la calidad y durabilidad del producto. Es importante recordar que los pesos muestran en caso de ser DISTRIBUIDA en toda el área de la plataforma.

**EN:** Please pay attention to the maximum weights supported by each compartment product. Be careful not to exceed these weights, in order to ensure the quality and durability of the product. It is important to remember also that the weights shown should be DISTRIBUTED throughout the area of the shelf.

**PT:** Por favor, preste atenção aos pesos máximos suportados por cada compartimento do produto. Cuide para não exceder esses pesos, afim de garantir a qualidade e a durabilidade do mesmo. É importante lembrar também que, os pesos mostrados devem ser DISTRIBUÍDOS ao longo de toda a área da peça.

**FR:** Veuillez faire attention aux poids maximums supportés par chaque compartiment du produit. Veuillez à ne pas dépasser ces poids, afin de garantir la qualité et la durabilité du produit. Il est également important de se rappeler que les poids indiqués doivent être RÉPARTIS sur toute la surface du rayon.

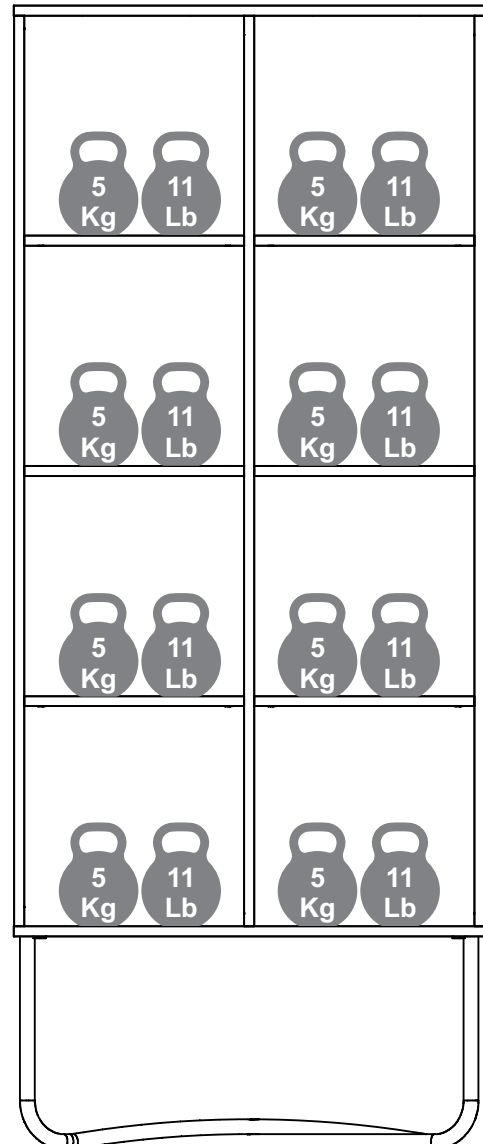



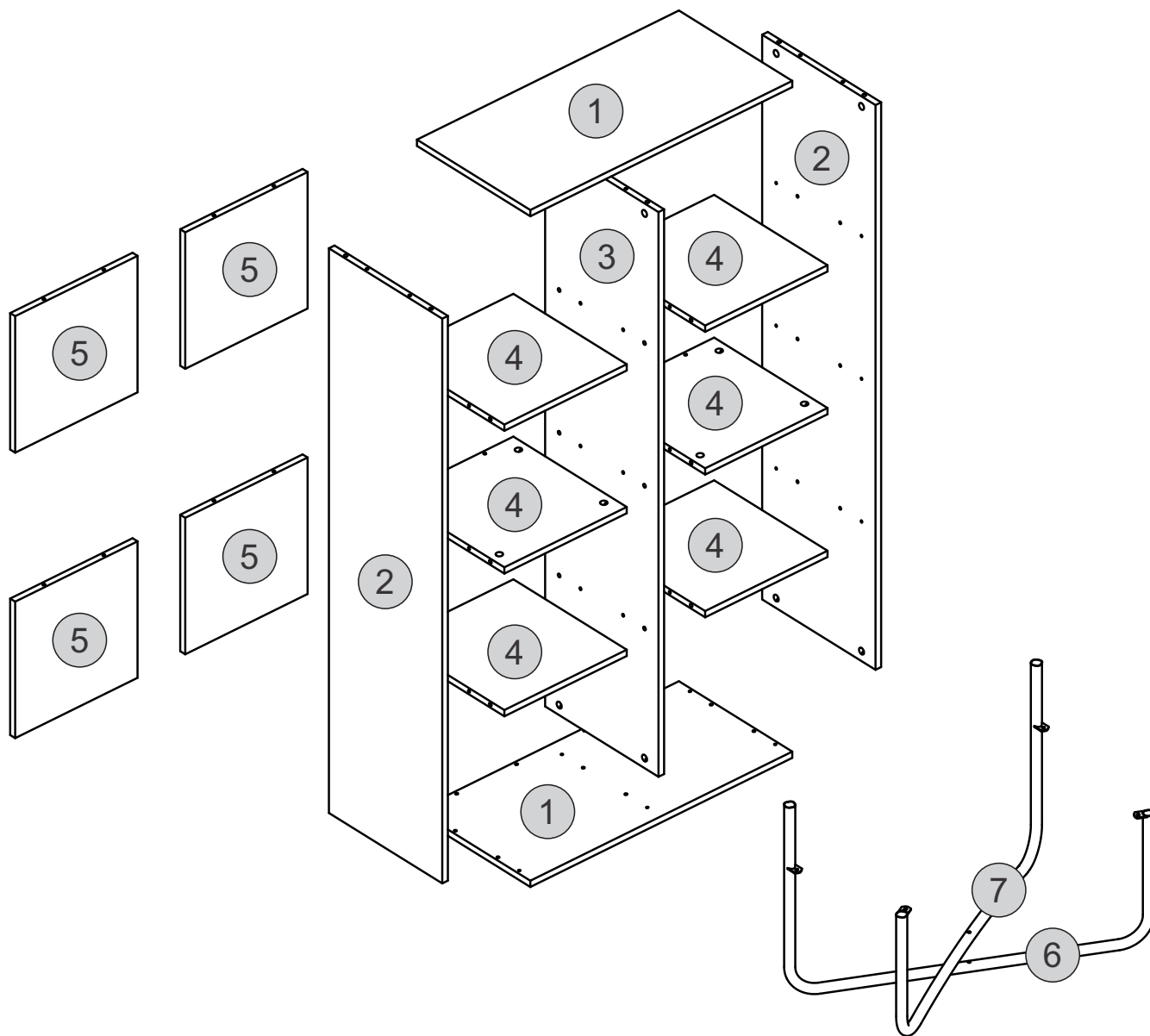



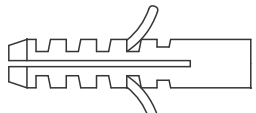
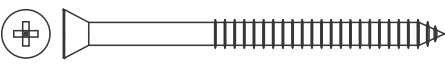

**Conocer mejor las piezas de su producto**  
**Getting to know your product parts better**  
**Conhecendo melhor as peças do seu produto**  
**Mieux connaître les pièces de votre produit**

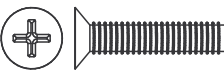
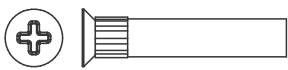
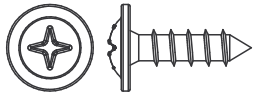
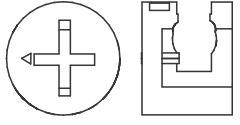
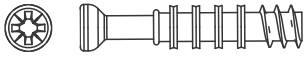

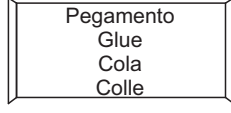
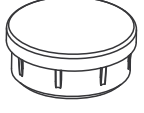
#	Ct. Qt.	Español	English	Português	Français	mm in
1	2	Base-Tapa	Base-Top Panel	Base-Tampo	Base-Partie Supérieure	700 x 340 x 15mm 27,56 x 13,39 x 0,59in
2	2	Lateral	Side Panel	Lateral	Latéral	1353 x 340 x 15mm 53,27 x 13,39 x 0,59in
3	1	División	Division Panel	Divisão	Division	1353 x 340 x 15mm 53,27 x 13,39 x 0,59in
4	6	Repisa	Shelf	Prateleira	Étagère	327 x 340 x 15mm 12,87 x 13,39 x 0,59in
5	4	Costado	Back Panel	Costa	Pièce Arrière	327 x 327 x 15mm 12,87 x 12,87 x 0,59in
6	1	Pie Inferior	Bottom Foot	Pé Inferior	Pied Inférieur	760 x 460 x 23mm 29,92 x 18,11 x 0,91in
7	1	Pie Superior	Upper Foot	Pé Superior	Pied Supérieur	760 x 460 x 23mm 29,92 x 18,11 x 0,91in

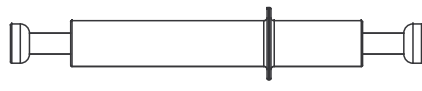
**Y** estos son sus Accesorios  
**A**nd these are your Accessories  
**E**stes são os seus Acessórios  
**ET** voici vos Accessoires

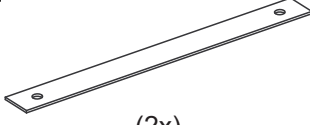
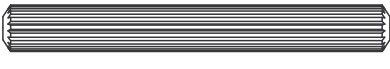
<p><b>A</b></p>  <p>(4x)</p>	<p><b>B</b></p>  <p>Ø6mm/0,24in (2x)</p>	<p><b>C</b></p>  <p>Ø4x50mm/0,16x1,97in (2x)</p>	<p><b>D</b></p>  <p>(42x)</p>
<p><b>E</b></p>  <p>Ø4x20mm/0,16x0,79in (1x)</p>	<p><b>F</b></p>  <p>Ø4x27mm/0,16x1,06in (1x)</p>	<p><b>G</b></p>  <p>Ø4x14mm/0,16x0,55in (6x)</p>	<p><b>H</b></p>  <p>(36x)</p>
<p><b>I</b></p>  <p>(24x)</p>	<p><b>J</b></p>  <p>Ø6x30mm/0,24x1,18in (40x)</p>	<p><b>K</b></p>  <p>(1x)</p>	<p><b>L</b></p>  <p>(2x)</p>
<p><b>M</b></p>  <p>Ø4x35mm/0,16x1,38in (4x)</p>	<p><b>N</b></p>  <p>(6x)</p>	<p><b>O</b></p>  <p>(4x)</p>	<p><b>P</b></p>  <p>(2x)</p>
<p><b>Q</b></p>  <p>Ø6x50mm/0,24x1,97in (6x)</p>			

**Y** si lo necesitas, mide en la regla al lado  
**A**nd if you need to, measure on the ruler beside  
**E** se precisar, meça na régua ao lado  
**ET** si vous en avez besoin, mesurez sur la règle à côté

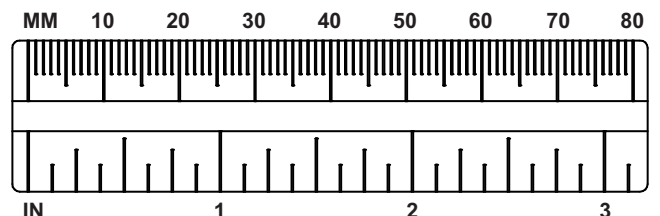

**Y** aquí, algunos Consejos de Montaje  
**A**nd here, some Assembly Tips  
**E**aquí, algumas Dicas de Montagem  
**E**T ici, quelques Conseils de Montage

**CONSEJOS DE MONTAJE PARA EL SISTEMA MINIFIX / TIPS FOR FITTINGS CAM-LOCKS**  
**DICAS DE MONTAGEM DO SISTEMA MINIFIX / CONSEILS D'ASSEMBLAGE DU SYSTEME MINIFIX**

**TAMBOR DEL MINIFIX / CAM NUT / TAMBOR MINIFIX / TAMBOUR MINIFIX**

**ES:** AL MONTAR EL TAMBOR DEL MINIFIX, ASEGÚRESE DE QUE LA POSICIÓN INICIAL ES CORRECTA, ANTES DE INSERTAR EL TORNILLO DEL MINIFIX, Y GIRE EN EL SENTIDO DE LAS AGUJAS DEL RELOJ HASTA QUE QUEDE ASEGURADO.

**EN:** WHEN FITTING CAM NUT, ENSURE STARTING POSITION IS CORRECT BEFORE YOU INSERT CONNECTING CAM BOLT TURN CLOCKWISE UNTIL SECURE

**PT:** AO ENCAIXAR O TAMBOR MINIFIX, CERTIFIQUE-SE DE QUE A POSIÇÃO INICIAL ESTEJA CORRETA, ANTES DE INSERIR NO PARAFUSO MINIFIX, E GIRE NO SENTIDO HORÁRIO ATÉ FIXAR.

**FR:** LORS DU MONTAGE DU TAMBOUR MINIFIX, ASSUREZ-VOUS QUE LA POSITION INITIALE EST CORRECTE, AVANT D'INSÉRER LA VIS MINIFIX, ET TOURNEZ DANS LE SENS DES AIGUILLES D'UNE MONTRE JUSQU'À CE QU'ELLE SOIT FIXÉE.

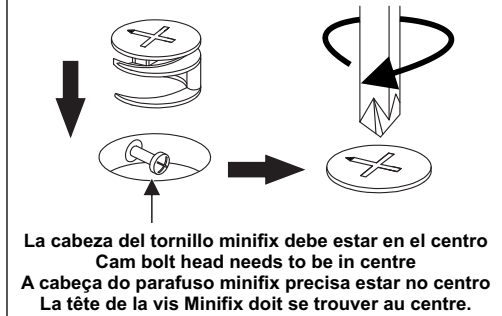
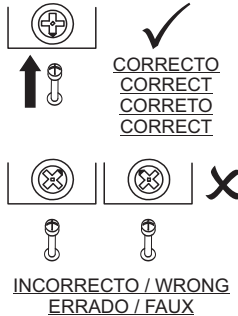

**TORNILLO DEL MINIFIX / CAMBOLT / PARAFUSO MINIFIX / VIS MINIFIX**

**ES:** APRIETE HASTA QUE LA VARILLA QUEDE A RAS DEL PANEL. NO APRIETE EN EXCESO NI EN DEFECTO (VÉANSE LOS EJEMPLOS AL LADO).

**EN:** TIGHTEN UNTIL SHOULDER IS FLUSH WITH PANEL. DO NOT OVERTIGHTEN OR UNDERTIGHTEN (SEE EXAMPLES BESIDE).

**PT:** APERTAR ATÉ A HASTE NIVELAR COM O PAINEL. NÃO APERTAR DEMAIS OU APERTAR POUCO (VER EXEMPLOS AO LADO).

**FR:** SERREZ JUSQU'À CE QUE LA TIGE SOIT AU MÊME NIVEAU QUE LE PANNEAU. NE SERREZ PAS TROP OU PASASSEZ (VOIR EXEMPLES CI-CONTRE).

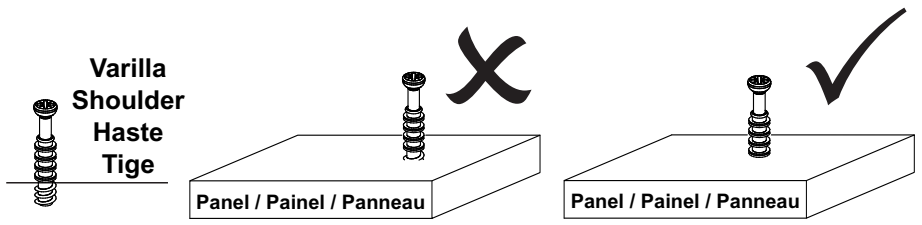

**HERRAMIENTAS NECESARIAS / TOOLS REQUIRED / FERRAMENTAS NECESSÁRIAS / OUTILS NÉCESSAIRES**

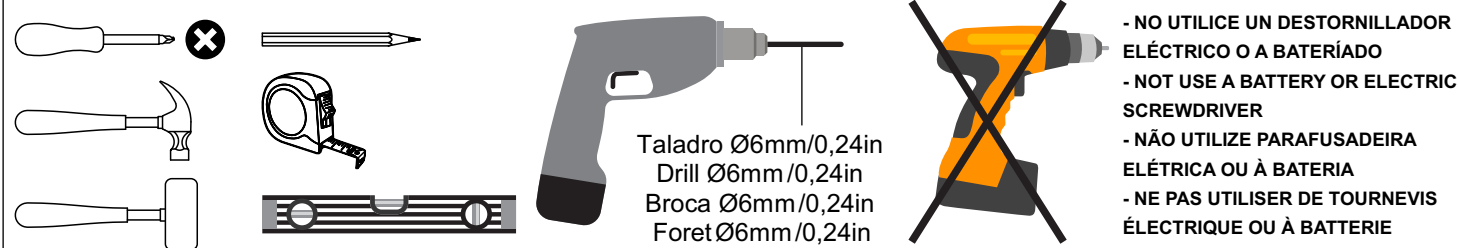

**NÚMERO DE PERSONAS Y ÁREA DE ARMADO**

**NUMBER OF PEOPLE AND ASSEMBLY AREA**

**NÚMERO DE PESSOAS E ÁREA DE MONTAGEM**

**NOMBRE DE PERSONNES ET ZONE DE RASSEMBLEMENT**

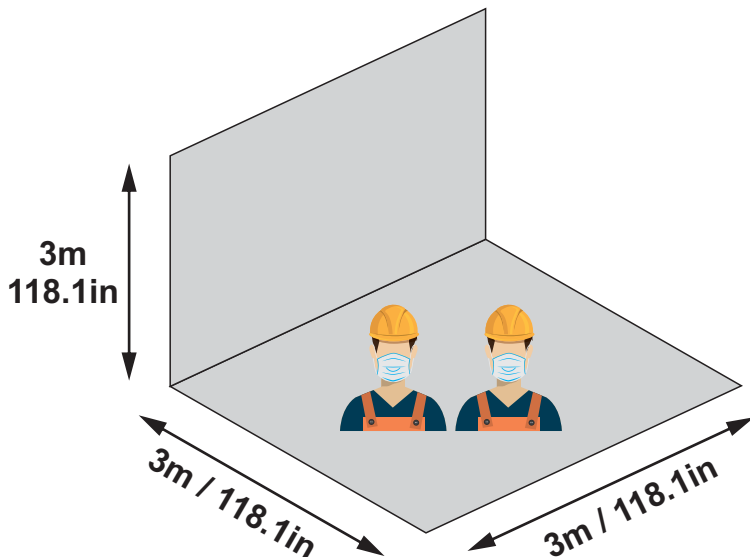

**ÁREA GRIS / GRAY AREA / ÁREA CINZA / ZONE GRISE**

**ES:** LAS ÁREAS MARCADAS CON COLOR GRIS SIGNIFICAN QUE ESTA PARTE DE LA PIEZA NO TIENE ACABADO, COMO LOS EJEMPLOS DE ABAJO.

**EN:** THE AREAS MARKED WITH THE COLOR GRAY MEAN THAT THIS PART OF THE PART IS NOT FINISHED, AS PER EXAMPLES BELOW.

**PT:** AS ÁREAS MARCADAS COM A COR CINZA SIGNIFICAM QUE ESSA PARTE DA PEÇA NÃO POSSUI ACABAMENTO, CONFORME EXEMPLOS ABAIXO.

**FR:** LES ZONES MARQUÉES D'UNE COULEUR GRISE SIGNIFIENT QUE CETTE PARTIE DE LA PIÈCE N'A PAS DE FINITION, COMME LES EXEMPLES CI-DESSOUS.

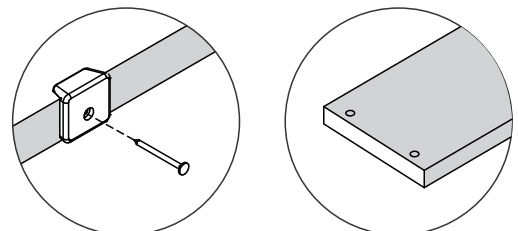



# 1

PIEZAS NECESARIAS  
PARTS REQUIRED  
PEÇAS NECESSÁRIAS  
PIÈCES NÉCESSAIRES

2	x2	3	x1
---	----	---	----

ACCESORIOS NECESARIOS  
HARDWARE REQUIRED  
ACESSÓRIOS NECESSÁRIOS  
ACCESSOIRES NÉCESSAIRES

I		12x
J	 Ø6x30mm/0.24x1.18in	12x
K		1x

HERRAMIENTAS NECESARIAS  
TOOLS REQUIRED  
FERRAMENTAS NECESSÁRIAS  
OUTILS NÉCESSAIRES

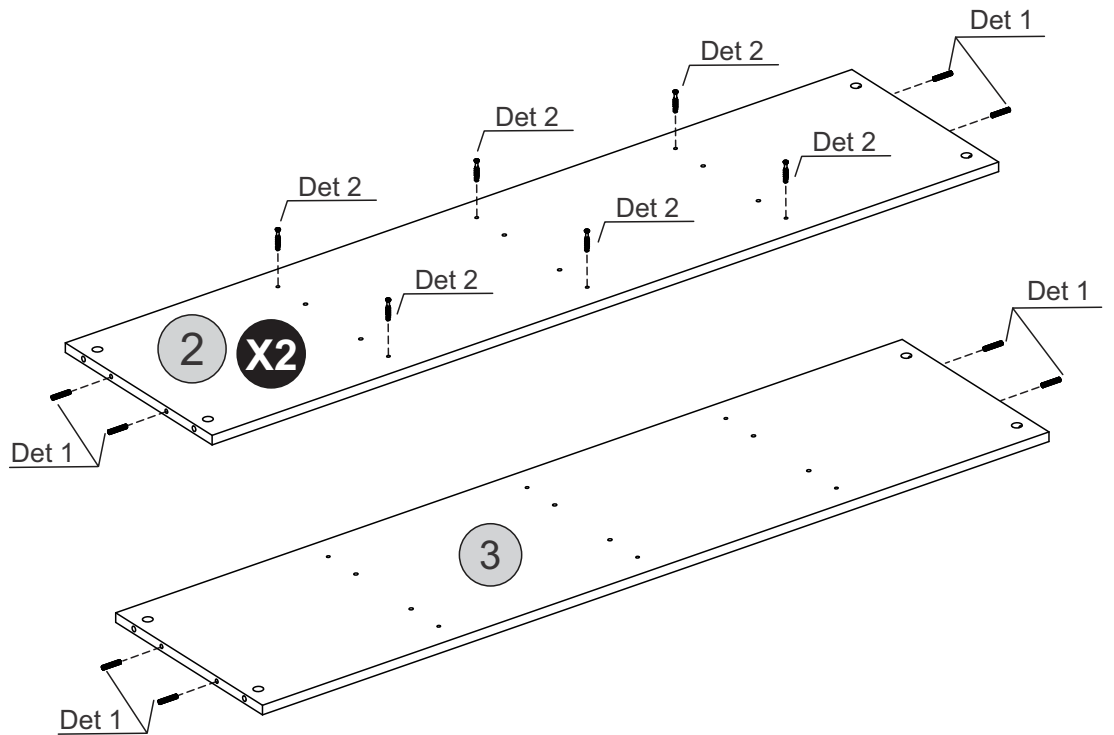
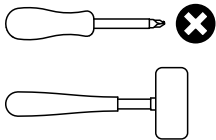

Detalle 1 / Detail 1  
Detalhe 1 / Détail 1



Detalle 2 / Detail 2  
Detalhe 2 / Détail 2

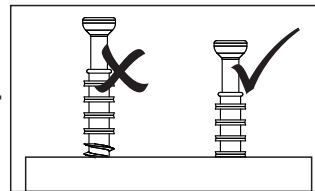
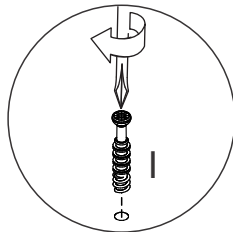



# 2

PIEZAS NECESARIAS  
PARTS REQUIRED  
PEÇAS NECESSÁRIAS  
PIÈCES NÉCESSAIRES

1	x2	4	x6	5	x4
---	----	---	----	---	----

ACCESORIOS NECESARIOS  
HARDWARE REQUIRED  
ACESSÓRIOS NECESSÁRIOS  
ACCESSOIRES NÉCESSAIRES

I		12x
J	 Ø6x30mm/0.24x1.18in	28x
K		1x

HERRAMIENTAS NECESARIAS  
TOOLS REQUIRED  
FERRAMENTAS NECESSÁRIAS  
OUTILS NÉCESSAIRES

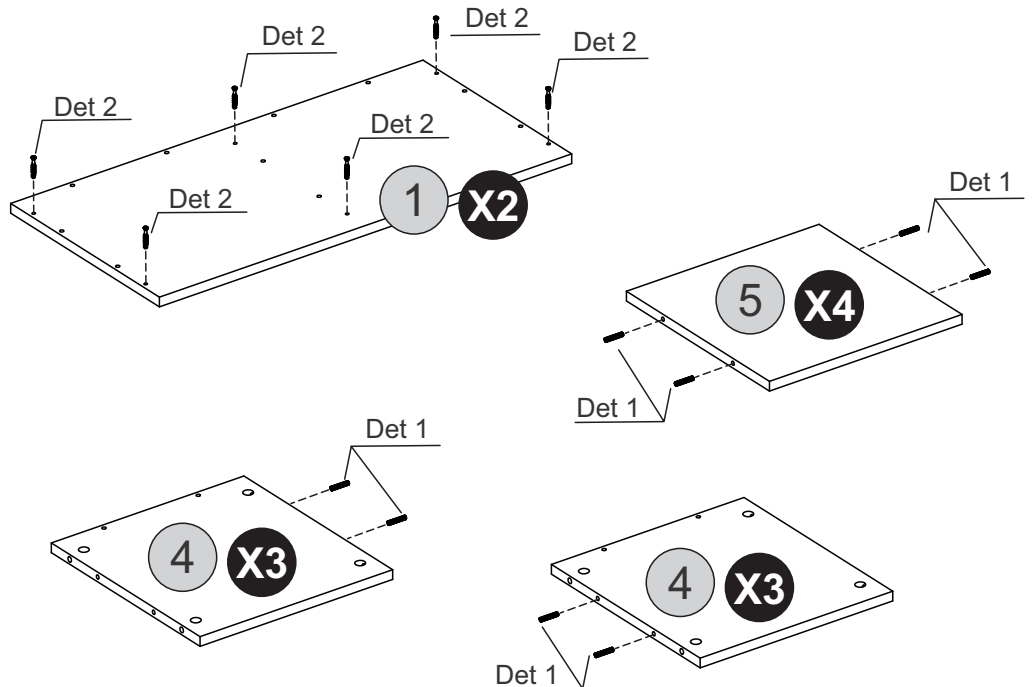
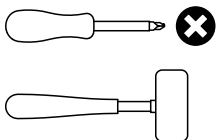

Detalle 1 / Detail 1  
Detalhe 1 / Détail 1



Detalle 2 / Detail 2  
Detalhe 2 / Détail 2

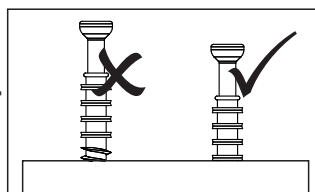
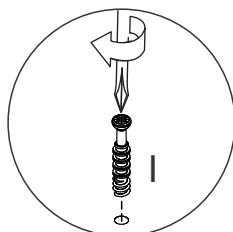

# 3

# X2

PIEZAS NECESARIAS  
PARTS REQUIRED  
PEÇAS NECESSÁRIAS  
PIÈCES NÉCESSAIRES

4 x4 5 x2

ACCESORIOS NECESARIOS  
HARDWARE REQUIRED  
ACESSÓRIOS NECESSÁRIOS  
ACCESSOIRES NÉCESSAIRES

K  1x

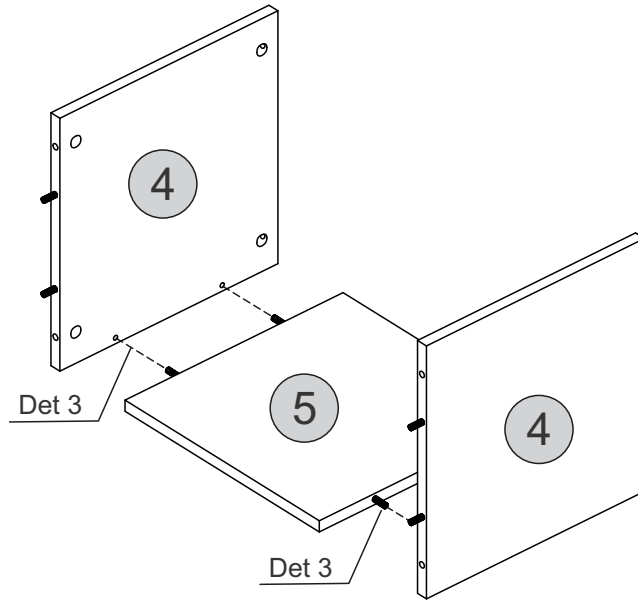

Detalle 3 / Detail 3  
Detalhe 3 / Détail 3

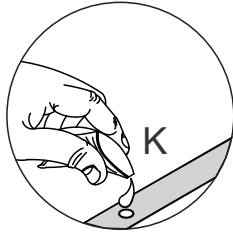

# 4

PIEZAS NECESARIAS  
PARTS REQUIRED  
PEÇAS NECESSÁRIAS  
PIÈCES NÉCESSAIRES

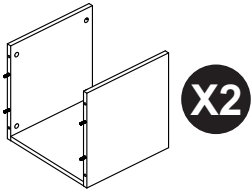

3 x1 4 x2

ACCESORIOS NECESARIOS  
HARDWARE REQUIRED  
ACESSÓRIOS NECESSÁRIOS  
ACCESSOIRES NÉCESSAIRES

D  12x

H  12x

N  6x

Q  6x  
Ø6x50mm/0,24x1,97in

HERRAMIENTAS NECESARIAS  
TOOLS REQUIRED  
FERRAMENTAS NECESSÁRIAS  
OUTILS NÉCESSAIRES

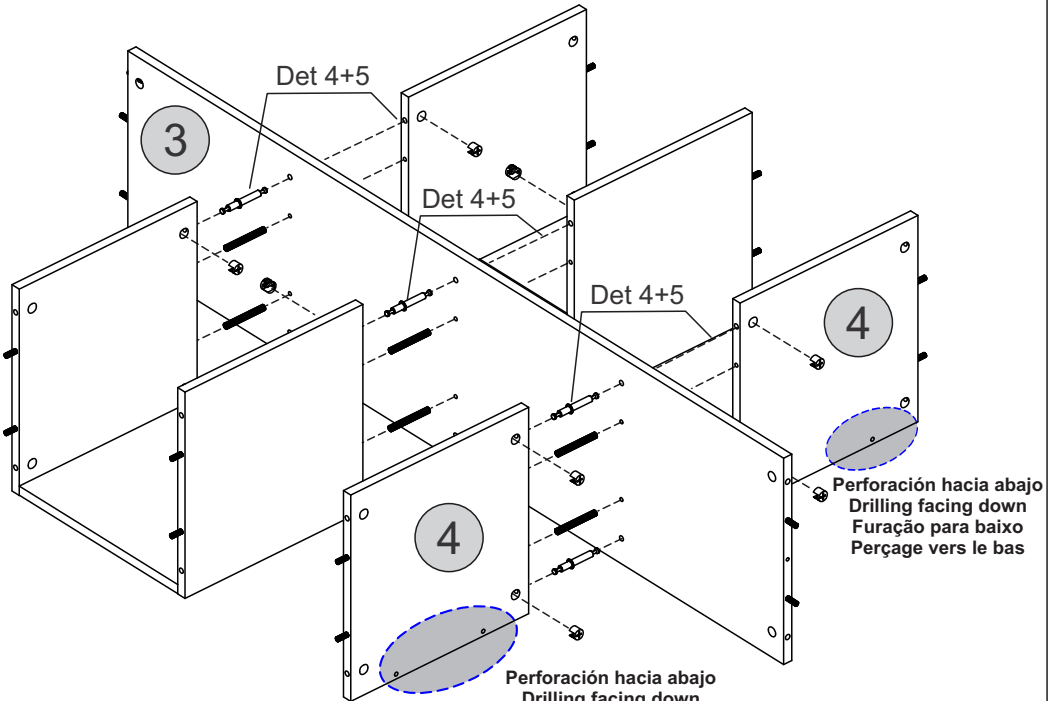
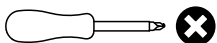

Detalle 4 / Detail 4  
Detalhe 4 / Détail 4

Detalle 5 / Detail 5  
Detalhe 5 / Détail 5

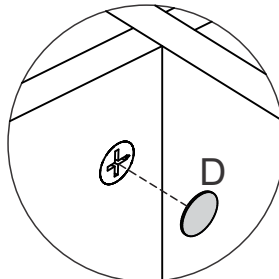
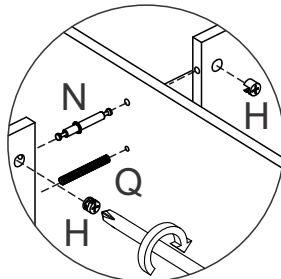



# 5

PIEZAS NECESARIAS  
PARTS REQUIRED  
PEÇAS NECESSÁRIAS  
PIÈCES NÉCESSAIRES

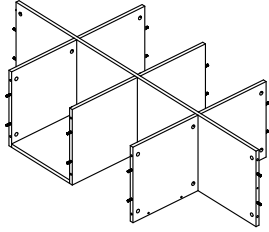

2 x2

ACCESORIOS NECESARIOS  
HARDWARE REQUIRED  
ACESSÓRIOS NECESSÁRIOS  
ACCESSOIRES NÉCESSAIRES

D  12x

H  12x

HERRAMIENTAS NECESARIAS  
TOOLS REQUIRED  
FERRAMENTAS NECESSÁRIAS  
OUTILS NÉCESSAIRES

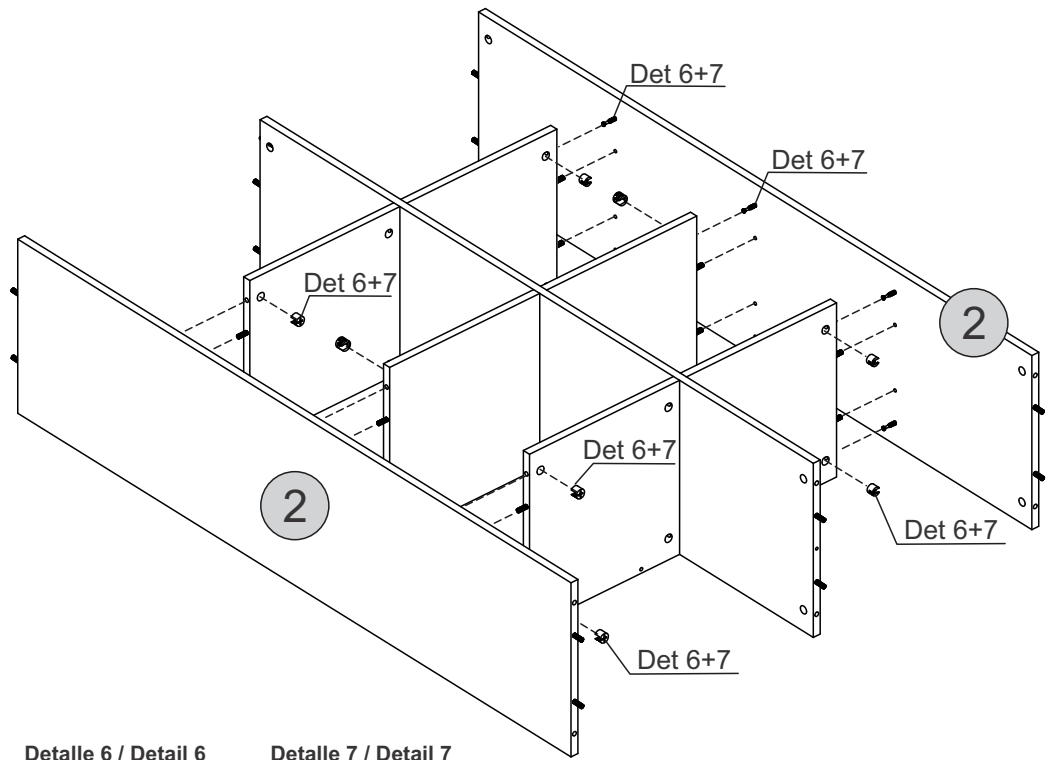
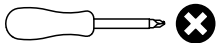

Detalle 6 / Detail 6  
Detalhe 6 / Détail 6

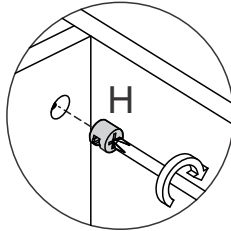

Detalle 7 / Detail 7  
Detalhe 7 / Détail 7

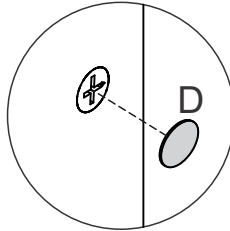

# 6

PIEZAS NECESARIAS  
PARTS REQUIRED  
PEÇAS NECESSÁRIAS  
PIÈCES NÉCESSAIRES

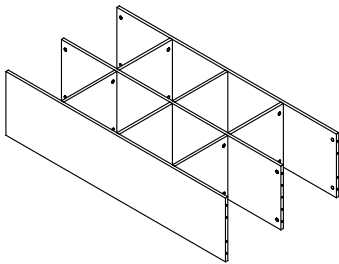

5 x2

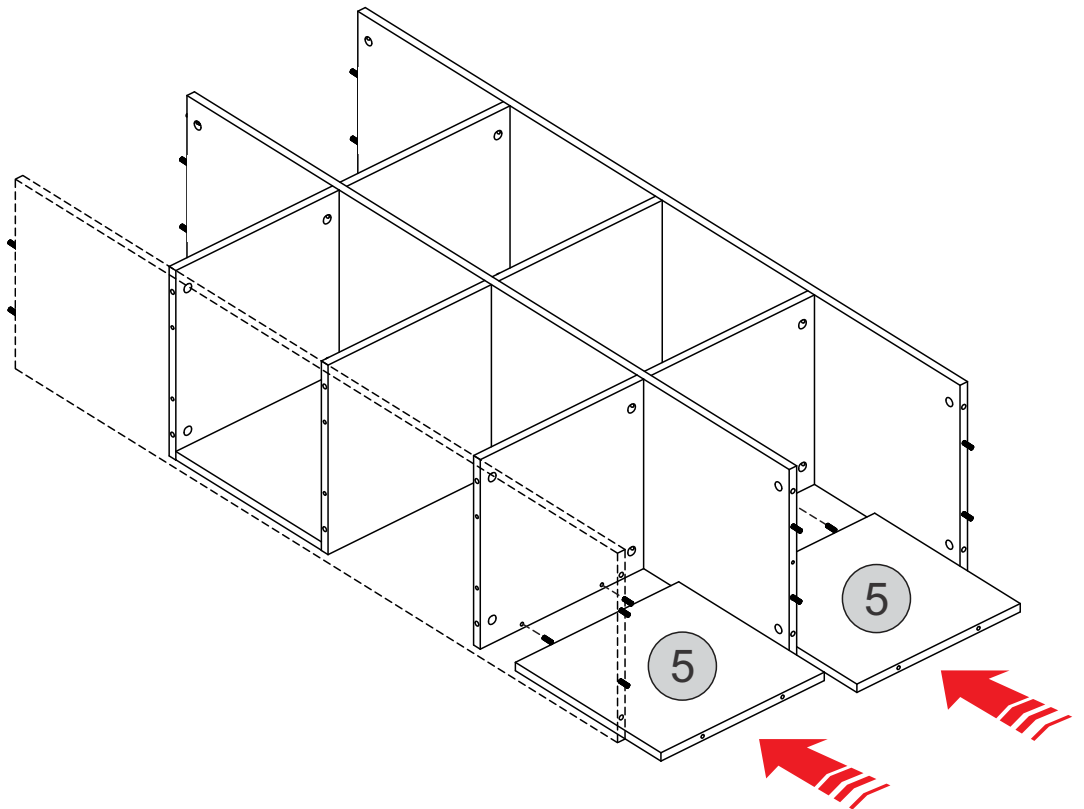

# 7

PIEZAS NECESARIAS  
PARTS REQUIRED  
PEÇAS NECESSÁRIAS  
PIÈCES NÉCESSAIRES

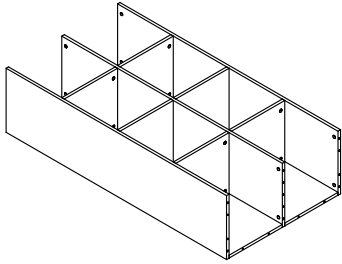

**1** x2

ACCESORIOS NECESARIOS  
HARDWARE REQUIRED  
ACESSÓRIOS NECESSÁRIOS  
ACCESSOIRES NÉCESSAIRES

**D** 12x

**H** 12x

HERRAMIENTAS NECESARIAS  
TOOLS REQUIRED  
FERRAMENTAS NECESSÁRIAS  
OUTILS NÉCESSAIRES

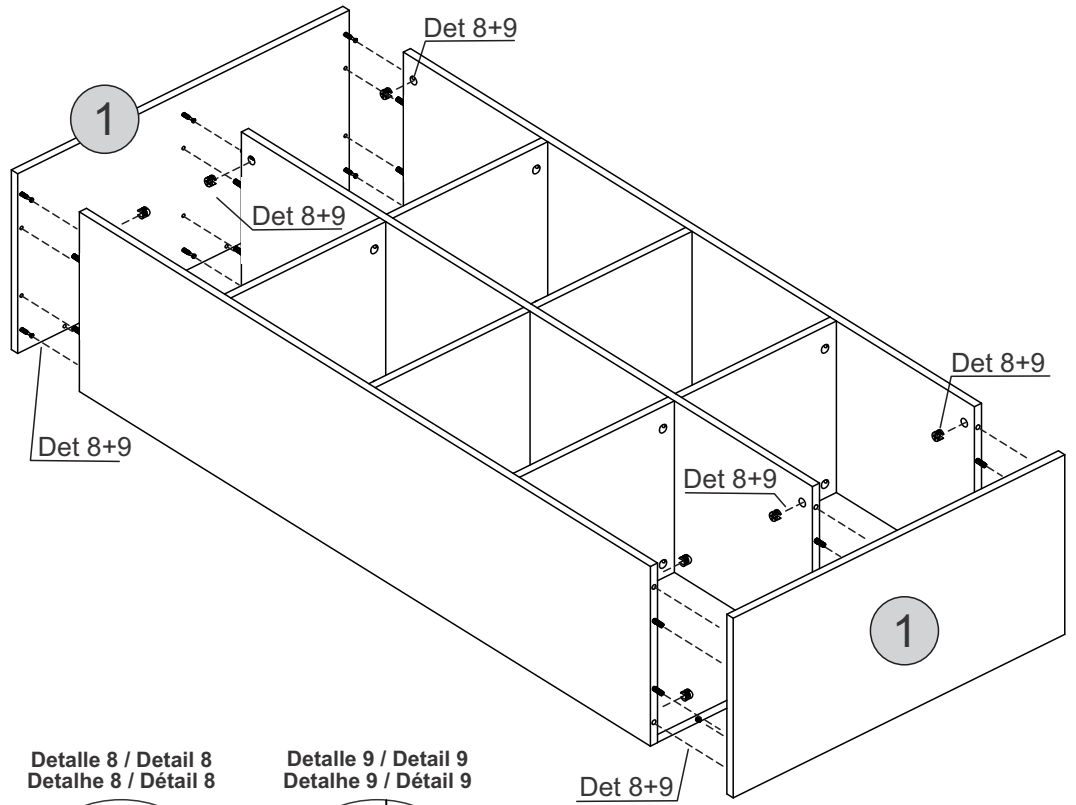
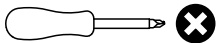

Detalle 8 / Detail 8  
Detalhe 8 / Détail 8

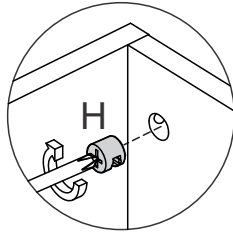

Detalle 9 / Detail 9  
Detalhe 9 / Détail 9

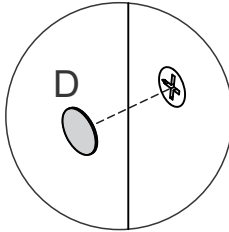

# 8

PIEZAS NECESARIAS  
PARTS REQUIRED  
PEÇAS NECESSÁRIAS  
PIÈCES NÉCESSAIRES

**6** x1 **7** x1

ACCESORIOS NECESARIOS  
HARDWARE REQUIRED  
ACESSÓRIOS NECESSÁRIOS  
ACCESSOIRES NÉCESSAIRES

**L** 2x

HERRAMIENTAS NECESARIAS  
TOOLS REQUIRED  
FERRAMENTAS NECESSÁRIAS  
OUTILS NÉCESSAIRES

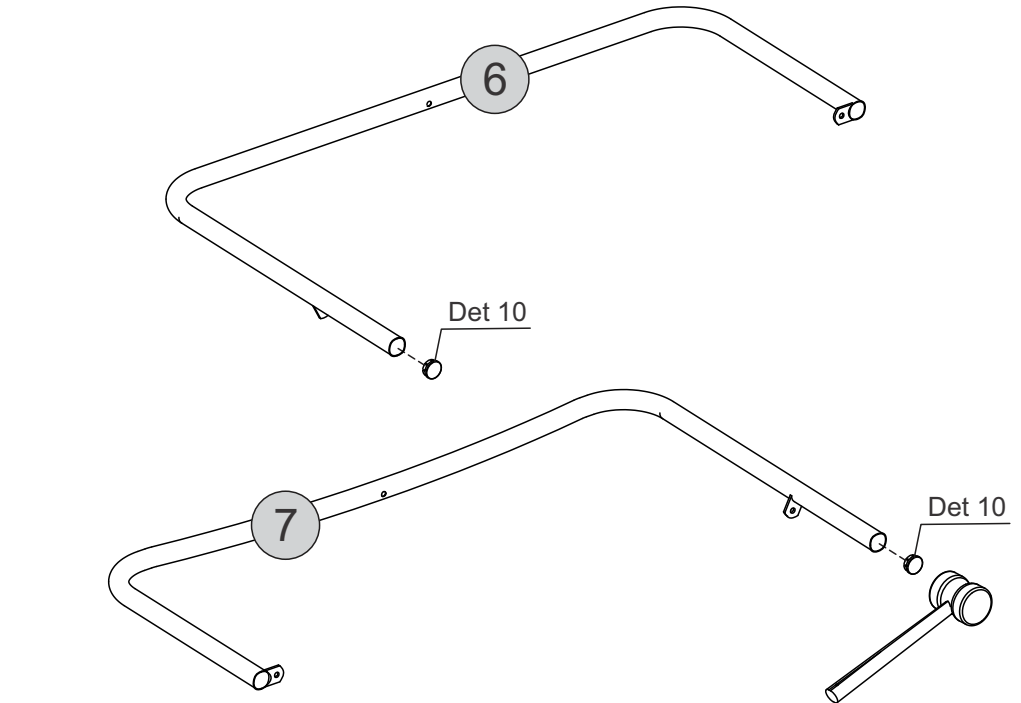
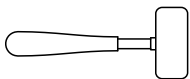

Detalle 10 / Detail 10  
Detalhe 10 / Détail 10

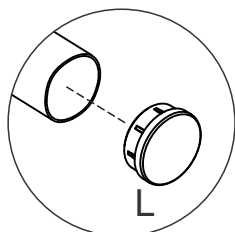

# 9

PIEZAS NECESARIAS  
PARTS REQUIRED  
PEÇAS NECESSÁRIAS  
PIÈCES NÉCESSAIRES

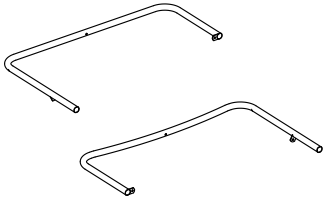

ACCESORIOS NECESARIOS  
HARDWARE REQUIRED  
ACESSÓRIOS NECESSÁRIOS  
ACCESSOIRES NÉCESSAIRES



HERRAMIENTAS NECESARIAS  
TOOLS REQUIRED  
FERRAMENTAS NECESSÁRIAS  
OUTILS NÉCESSAIRES

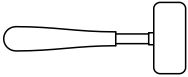

Detalle 11 / Detail 11  
Detalhe 11 / Détail 11

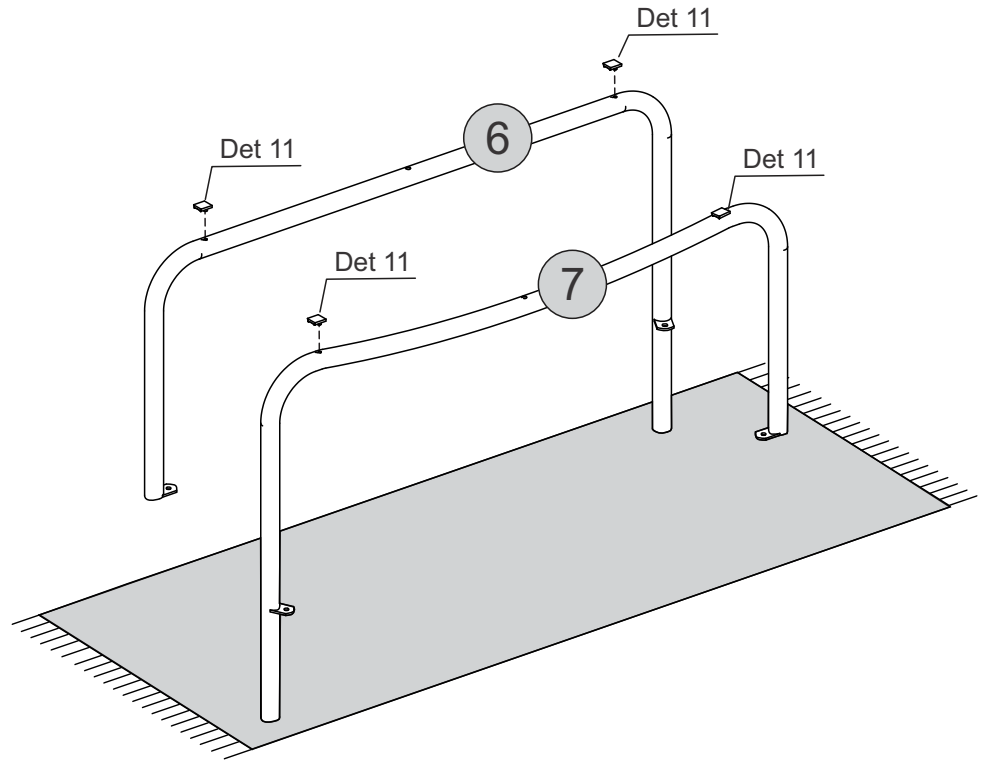
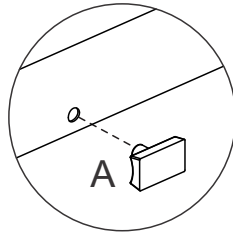

# 10

PIEZAS NECESARIAS  
PARTS REQUIRED  
PEÇAS NECESSÁRIAS  
PIÈCES NÉCESSAIRES

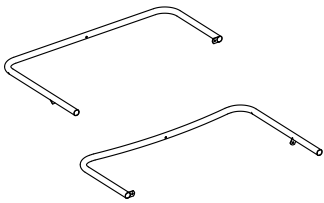

ACCESORIOS NECESARIOS  
HARDWARE REQUIRED  
ACESSÓRIOS NECESSÁRIOS  
ACCESSOIRES NÉCESSAIRES

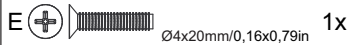

HERRAMIENTAS NECESARIAS  
TOOLS REQUIRED  
FERRAMENTAS NECESSÁRIAS  
OUTILS NÉCESSAIRES

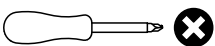

Detalle 12 / Detail 12  
Detalhe 12 / Détail 12

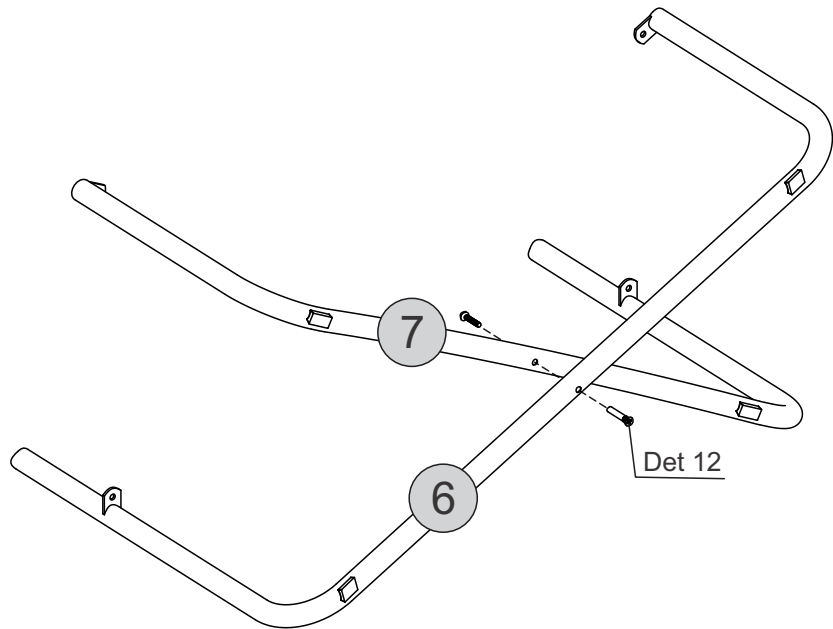
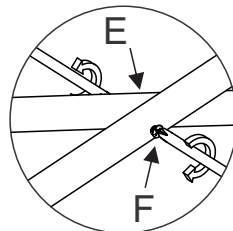

# 11

PIEZAS NECESARIAS/PARTS REQUIRED  
PEÇAS NECESSÁRIAS/PIÈCES NÉCESSAIRES

ACCESORIOS NECESARIOS  
HARDWARE REQUIRED  
ACESSÓRIOS NECESSÁRIOS  
ACCESÓRIOS NÉCESSAIRES

HERRAMIENTAS NECESARIAS  
TOOLS REQUIRED  
FERRAMENTAS NECESSÁRIAS  
OUTILS NÉCESSAIRES

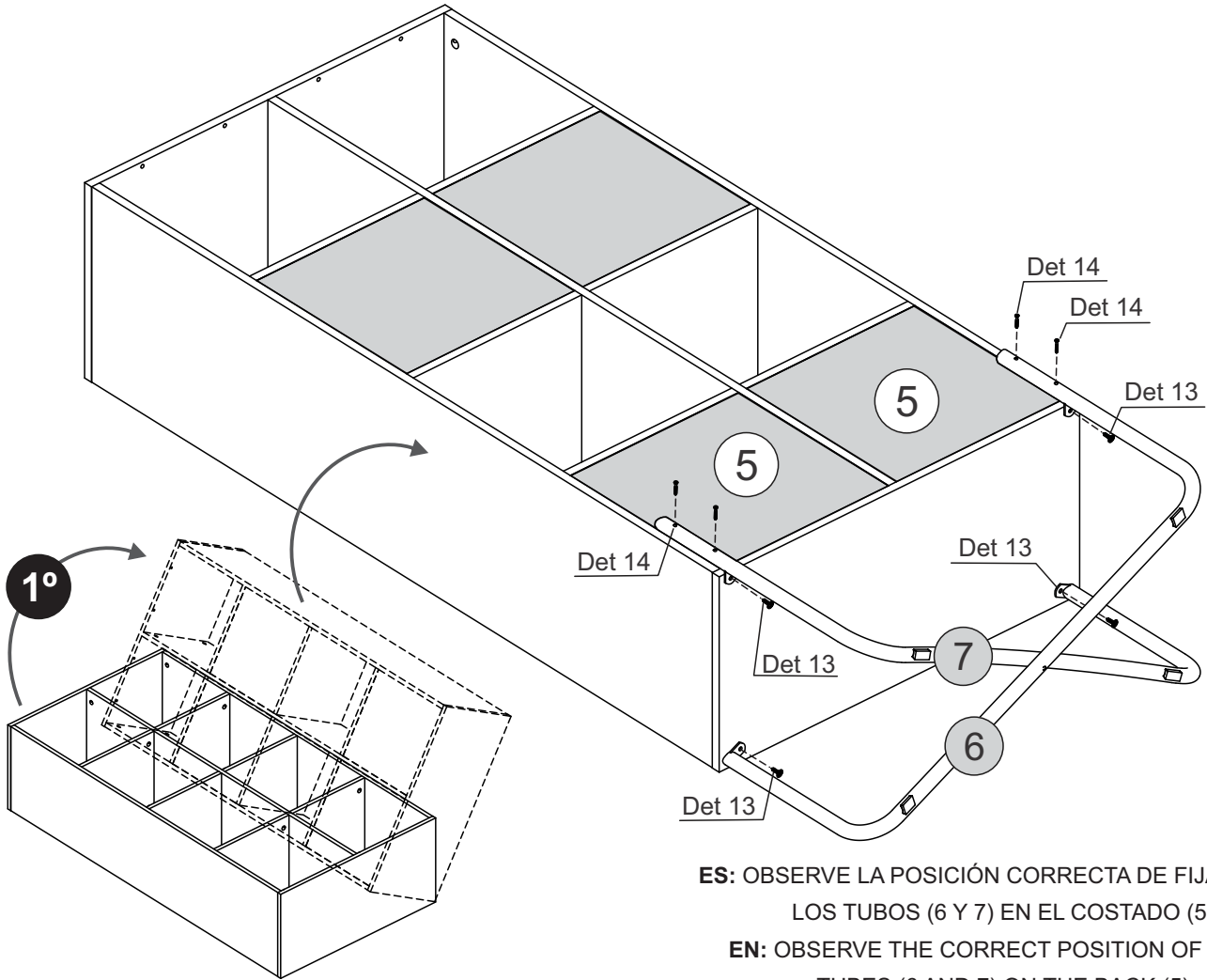
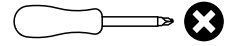
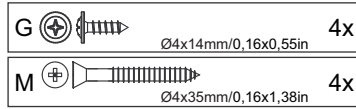
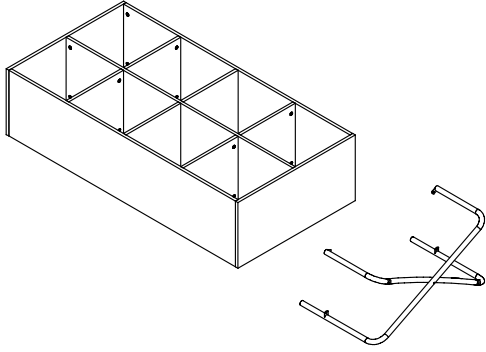

**ES:** OBSERVE LA POSICIÓN CORRECTA DE FIJACIÓN DE LOS TUBOS (6 Y 7) EN EL COSTADO (5).

**EN:** OBSERVE THE CORRECT POSITION OF FIXING TUBES (6 AND 7) ON THE BACK (5).

**PT:** OBSERVAR A POSIÇÃO CORRETA DE FIXAÇÃO DOS TUBOS (6 E 7) NA COSTA (5).

**FR:** OBSERVER LA POSITION CORRECTE DE FIXATION DES TUBES (6 ET 7) SUR LA RIVE (5).

Detalle 13 / Detail 13  
Detalhe 13 / Détail 13

Detalle 14 / Detail 14  
Detalhe 14 / Détail 14

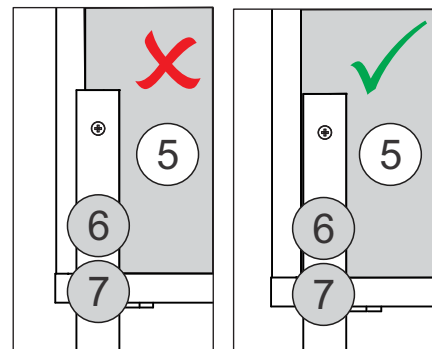
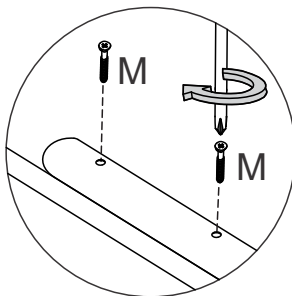
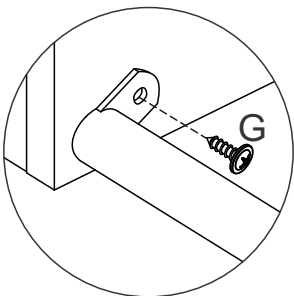

PIEZAS NECESARIAS/PARTS REQUIRED  
 PEÇAS NECESSÁRIAS/PIÈCES NÉCESSAIRES

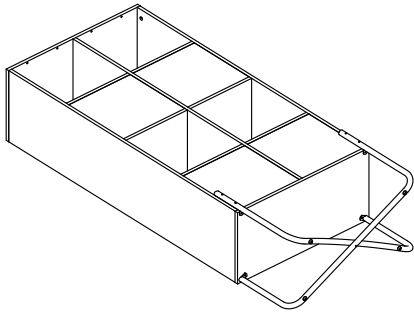

ACCESORIOS NECESARIOS  
 HARDWARE REQUIRED  
 ACESSÓRIOS NECESSÁRIOS  
 ACCESSOIRES NÉCESSAIRES

D		4x
G		2x
O		2x
P		2x

HERRAMIENTAS NECESARIAS  
 TOOLS REQUIRED  
 FERRAMENTAS NECESSÁRIAS  
 OUTILS NÉCESSAIRES

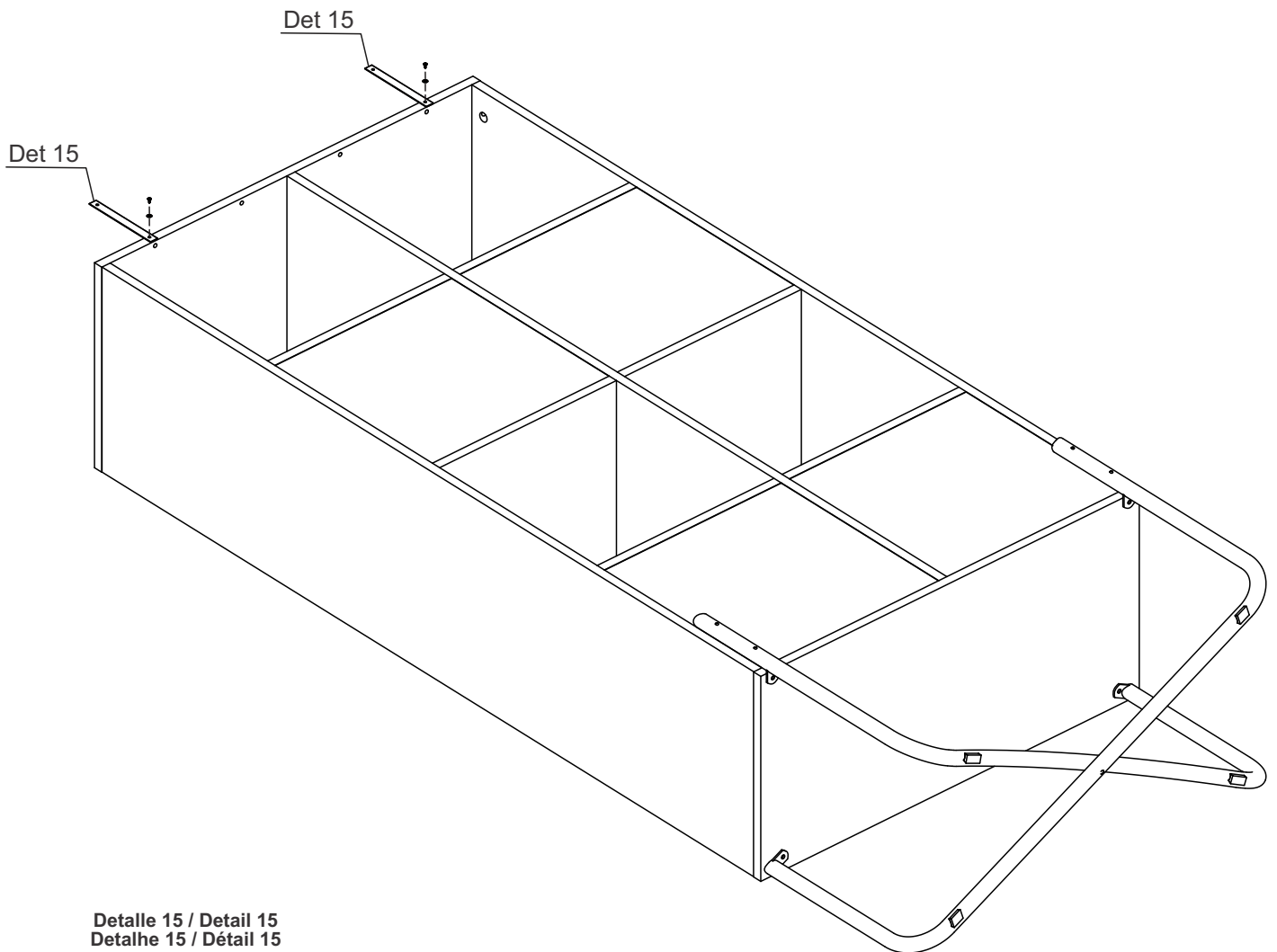
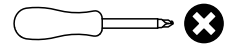

Detalle 15 / Detail 15  
 Detalhe 15 / Détail 15

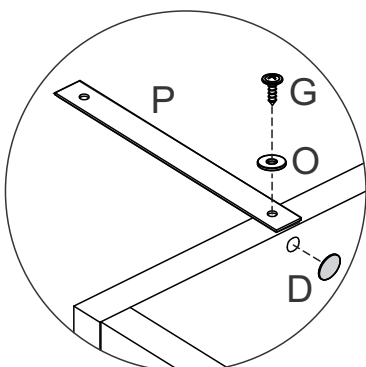

PIEZAS NECESARIAS/PARTS REQUIRED  
PEÇAS NECESSÁRIAS/PIÈCES NÉCESSAIRES

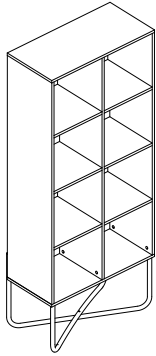

ACCESORIOS NECESARIOS  
HARDWARE REQUIRED  
ACESSÓRIOS NECESSÁRIOS  
ACCESSOIRES NÉCESSAIRES

B		2x
C	 Ø4 x 50mm/0,16 x 1,97in	2x
O		2x

HERRAMIENTAS NECESARIAS  
TOOLS REQUIRED  
FERRAMENTAS NECESSÁRIAS  
OUTILS NÉCESSAIRES

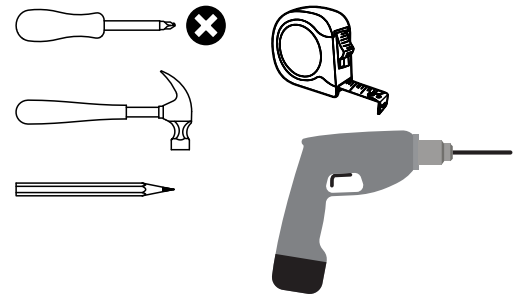

**ES:** ES OBLIGATORIO FIJAR ESTE PRODUCTO A LA PARED, COMO SE MUESTRA EN ESTE PASO. POR FAVOR, CONSULTE LOS DETALLES EN LA ÚLTIMA PÁGINA.

**EN:** IT IS OBLIGATORY TO FIX THIS PRODUCT TO THE WALL, AS SHOWN IN THIS STEP. PLEASE, CONSULT DETAILS IN THE LAST PAGE.

**PT:** É OBRIGATÓRIO FIXAR ESTE PRODUTO NA PAREDE, CONFORME DEMONSTRADO NESTE PASSO. POR FAVOR, CONSULTE OS DETALHES NA ÚLTIMA PÁGINA.

**FR:** IL FAUT IMPÉRATIVEMENT FIXER CE PRODUIT AU MUR COMME INDIQUÉ DANS CETTE ÉTAPE. VEUILLEZ VOUS RÉFÉRER AUX DÉTAILS DE LA DERNIÈRE PAGE.



Detalle 16 / Detail 16  
Detalhe 16 / Détail 16

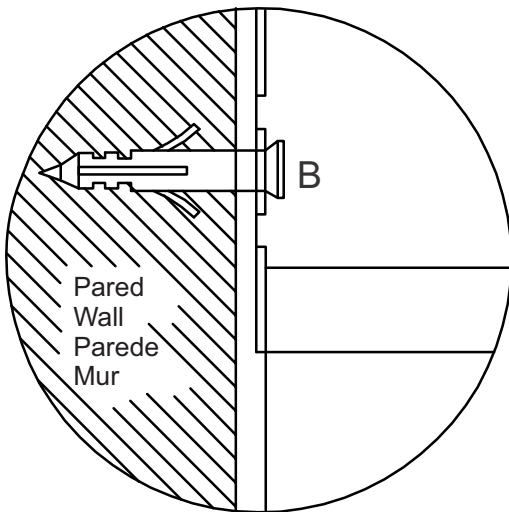

Detalle 17 / Detail 17  
Detalhe 17 / Détail 17

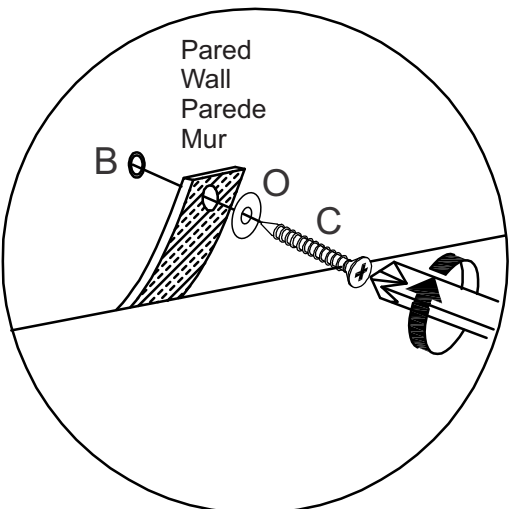

Det 16  
Det 17

Det 16  
Det 17

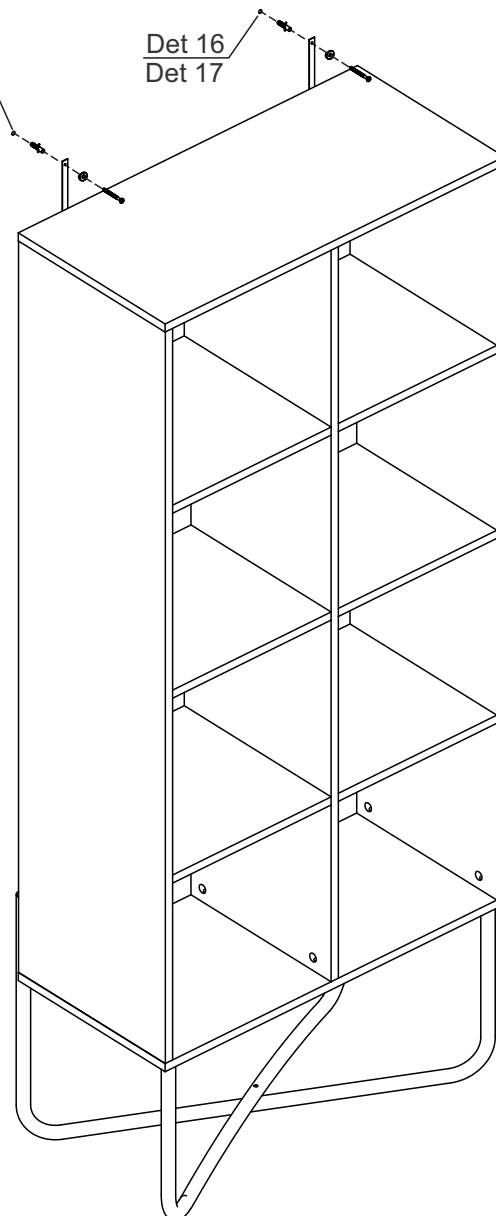

# Guía de Montaje/Fijación a la pared - Mounting Guide/Wall Fixings - Guia de Montagem/Fixações na Parede - Guide de montage/Fixations murales



1. Al taladrar en las paredes, compruebe siempre que no haya cables, tuberías ocultos, etc.
  2. Asegúrese de que los tornillos y bujes de la pared utilizados sean adecuados para soportar su producto. En caso de duda, consulte a un profesional cualificado.
1. When drilling into walls always check that there are no hidden wires, pipes, etc.
2. Make sure that the screws and wall plugs being used are suitable for supporting your product. Consult a qualified professional if you are unsure.
1. Atenção: Na furação em paredes, sempre verifique se não existem fios, tubos escondidos, etc.
2. Certifique-se de que os parafusos e buchas utilizados são adequados para suportar o seu produto. Em caso de dúvida, consulte um profissional qualificado.
1. Attention: Lorsque vous percez un mur, vérifiez toujours qu'il n'y a pas de fils, de tuyaux ou de câbles cachés, etc
2. Assurez-vous que les vis et les chevilles utilisées sont adaptées au support de votre produit. En cas de doute, consultez un professionnel qualifié.



1. Asegúrese de usar el taladro correcto para que coincida con el buje de la pared y el tamaño del taladro.
  2. Asegúrese de taladrar el agujero horizontalmente, no fuerce la taladradora ni agrande el agujero.
  3. Asegúrese de que los bujes de la pared estén bien asentados y apretados en los orificios.
1. Ensure to use the recommended drill bit to match the wall plug and hole size.
2. Ensure to drill the hole horizontally, do not force the drill or enlarge the hole.
  3. Ensure wall plugs are well fitted and are a tight fit in the drilled hole.
1. Certifique-se de utilizar a broca correta para combinar com a bucha de parede e o tamanho da furação.
2. Certifique-se de fazer o furo na horizontal, não force ou aumente o diâmetro do furo.
  3. Certifique-se de que as buchas de parede estão bem encaixadas e apertadas nas furações.
1. Veillez à utiliser le bon foret pour correspondre à la cheville murale et à la taille du trou.
2. Veillez à percer le trou horizontalement, ne forcez pas et n'augmentez pas le diamètre du trou.
  3. Veillez à ce que les chevilles murales soient correctement installées et ajustées dans les trous.



## Buje Plástica 6mm/0,24in (suministradas) / 6mm/0,24in Plastic Wall Plug (supplied) Bucha Plástica 6mm/0,24in (fornecidas) / Cheville en plastique 6mm/0,24in (fournie)

1. Estos bujes de pared de plástico sólo son adecuados para su uso en paredes de mampostería.
  2. La falla del producto debido al uso de fijaciones incorrectas es responsabilidad del instalador.
1. These types of wall plugs are only suitable for use in masonry walls.
2. Failure of the product due to using incorrect fixings is the responsibility of the installer.
1. Estas buchas plásticas de parede são adequadas somente para uso em paredes de alvenaria.
2. A falha do produto devido à utilização de fixações incorretas é de responsabilidade do instalador.
1. Ces chevilles en plastique ne peuvent être utilisées que dans des murs en maçonnerie.
2. La défaillance du produit due à l'utilisation de fixations incorrectes est la responsabilité de l'installateur.

## Tipos de Pared y Fijaciones / Wall Types and Fixings / Tipos de Parede e Fixações / Types de murs et de fixations

**ES:** En la siguiente tabla se muestran ejemplos de modelos de bujes de pared y su aplicación según el material de la pared. **ATENCIÓN**, ya que todas las cargas soportadas son válidas siempre que la instalación cumpla con las especificaciones ideales. En caso de duda, consulte a un profesional cualificado para la correcta instalación.

**EN:** In the table below, examples of models of wall plugs and their application according to the material of the wall. **ATTENTION**, as all supported loads are valid as long as the installation complies with the ideal specifications. In case of doubt, consult a qualified professional for the correct installation.

**PT:** Na tabela abaixo, exemplos de modelos de buchas de parede e sua aplicação conforme o material da parede. **ATENÇÃO**, pois todas as cargas suportadas são válidas desde que a instalação respeite as indicações ideais. Em caso de dúvidas, consulte um profissional qualificado para a correta instalação.

**FR:** Dans le tableau ci-dessous, des exemples de types de chevilles murales et leur application en fonction du type de mur. **ATTENTION**, toutes les charges supportées sont valables à condition que l'installation respecte les indications idéales. En cas de doute, consultez un professionnel qualifié pour une installation correcte.

### Modelos de Bujes de Pared / Models of Wall Plugs / Modelos de Buchas / Type de Cheville

Tipos de Pared Wall Types Tipos de Parede Types de Murs											
Hormigón Concrete Concreto Béton	✓	✓	✓								✓
Bloque de Hormigón Concrete Block Bloco de Concreto Bloc de Béton	✓	✓	✓	✓	✓						
Ladrillo Hueco Hollow Brick Tijolo Oco Brique Creuse		✓	✓	✓	✓						
Ladrillo Macizo Solid Brick Tijolo Maciço Brique Solide	✓	✓	✓								✓
Paneles de yeso (Drywall) Drywall Painel de Drywall Panneau de Cloison Sèche			✓		✓	✓	✓	✓	✓	✓	