

Este es el producto que ha comprado!
This is the product you have purchased!
Esse é o produto que você adquiriu!
Voici le produit que vous avez acheté!

Ref. 1270

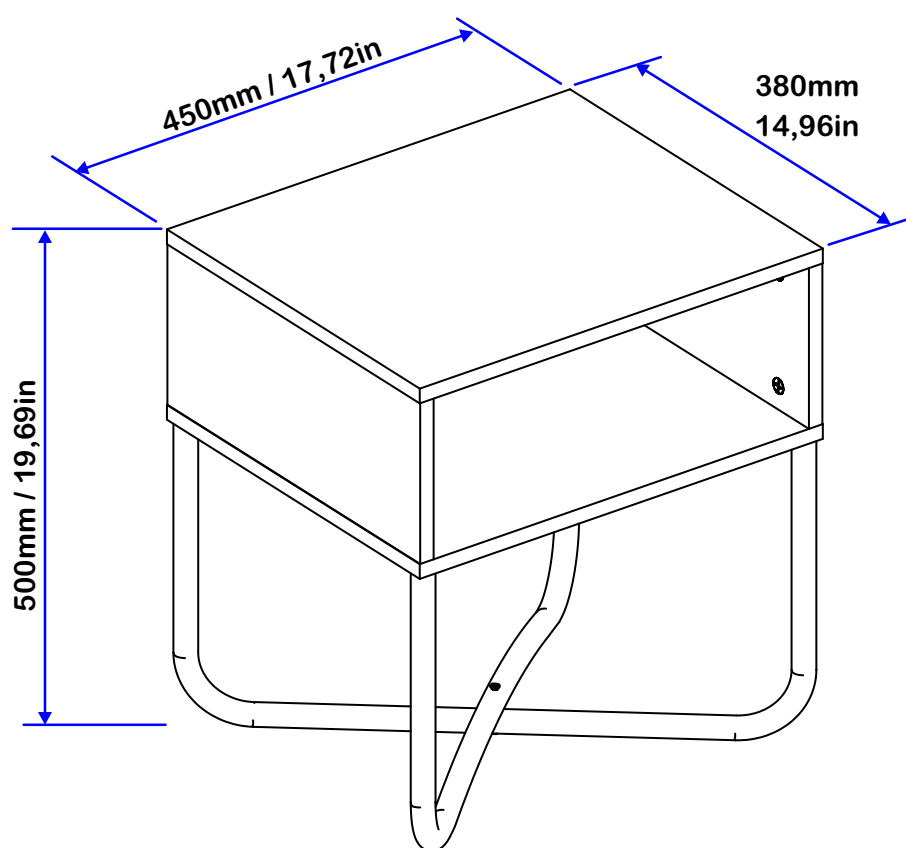

RECOMENDACIONES PARA EL USO Y CUIDADO DEL PRODUCTO
RECOMMENDATIONS FOR THE USE AND CARE OF THE PRODUCT
RECOMENDAÇÕES DE USO E CUIDADOS COM O PRODUTO
RECOMMANDATIONS POUR L'UTILISATION ET L'ENTRETIEN DU PRODUIT



Lea cuidadosamente el manual y siga en el orden indicado las instrucciones de ensamble.
 Read the manual carefully and follow the assembly instructions in the order listed.
 Leia o manual com atenção e siga as instruções de montagem na ordem listada.
 Lisez attentivement le manuel et suivez les instructions de montage dans l'ordre indiqué.



Ubica tus productos en una superficie lisa y plana. Utilice una protección entre el mueble y el piso.
 Place your products on a smooth, flat surface. Use a protection between the furniture and the floor.
 Coloque seus produtos em uma superfície lisa e plana. Use uma proteção entre a mobília e o chão.
 Placez vos produits sur une surface lisse et plane. Utilisez une protection entre le meuble et le sol.



No pinte ni use elementos abrasivos para limpiar el mueble.
 Do not paint or use abrasive items to clean the furniture.
 Não pinte ou use itens abrasivos para limpar o móvel.
 Ne pas peindre ni utiliser d'objets abrasifs pour nettoyer l'armoire.

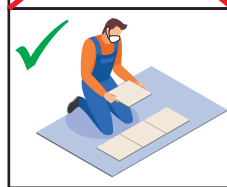

No exponga el mueble al calor ni a la humedad.
 Do not expose the furniture to heat or humidity.
 Não exponha a mobília ao calor ou umidade.
 N'exposez pas le meuble à la chaleur ou à l'humidité.

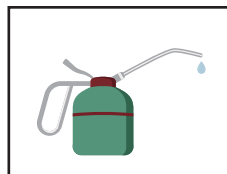

Se recomienda lubricar cada 3 meses rieles, correderas, bisagras y rodachinas.
 It is recommended to lubricate the rails, runners, hinges and castors every 3 months.
 Recomenda-se a lubrificação de trilhos, corredeiras, dobradiças e rodízios a cada 3 meses.
 Il est recommandé de lubrifier les rails, glissières, charnières et roulettes tous les 3 mois.



- No arraste el mueble, esto puede causar daños en las piezas.
 - Para desplazar el mueble asegúrese de moverlo cuando este vacío sin objetos.
 - Siempre solicite ayuda a otra persona para moverlo.
 - Do not drag the furniture, this can cause damage to the pieces.
 - To move the furniture be sure to move it when it is empty without objects.
 - Always ask someone else to help you move it.
 - Não arraste o móvel, pois isso pode causar danos às peças.
 - Para mover o móvel certifique-se de movê-lo quando estiver vazio e sem objetos.
 - Sempre peça a outra pessoa para ajudá-lo a movê-lo.
 - Ne traînez pas le meuble, cela peut endommager les pièces.
 - Pour déplacer le meuble veillez à le déplacer lorsqu'il est vide sans objets.
 - Demandez toujours à quelqu'un d'autre de vous aider à le déplacer.



No utilizar las gavetas como escaleras ni permitir que los niños se cuelguen de las puertas.
 Do not use drawers as ladders or allow children to hang from doors.
 Não use gavetas como escadas, nem permita que crianças se pendurem nas portas.
 N'utilisez pas les tiroirs comme échelles et ne laissez pas les enfants se suspendre aux portes.

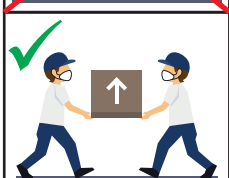

- Para mover el mueble certifique-se de movê-lo quando estiver vazio e sem objetos.
 - Sempre peça a outra pessoa para ajudá-lo a movê-lo.
 - Ne traînez pas le meuble, cela peut endommager les pièces.
 - Pour déplacer le meuble veillez à le déplacer lorsqu'il est vide sans objets.
 - Demandez toujours à quelqu'un d'autre de vous aider à le déplacer.



Evita que el trapeador o elementos similares entren en contacto con tus muebles ya que esto puede deteriorarlos.
 Avoid that the mop or similar elements come into contact with your furniture as this can deteriorate them.
 Evite que a esfregona ou elementos semelhantes entrem em contacto com os seus móveis, pois pode deteriorá-los.
 Évitez que la serpillière ou des éléments similaires entrent en contact avec vos meubles car cela peut les détériorer.



Limpia regularmente la madera con un paño de microfibra para que no se acumule el polvo y así evitar que el mueble pierda su brillo.
 Regularly clean the wood with a microfiber cloth so that dust does not accumulate and thus prevent the furniture from losing its shine.
 Limpe regularmente a madeira com um pano de microfibra para que o pó não se acumule e evite que o móvel perca o brilho.
 Nettoyez régulièrement le bois avec un chiffon microfibre afin que la poussière ne s'accumule pas et ainsi éviter que le meuble ne perde de son éclat.



Mantén alejado objetos puntiagudos como tijeras, llaves o cuchillos. Éstos pueden causar cortes y/o rayones.
 Keep sharp objects like scissors, keys, or knives away. These can cause cuts and / or scratches.
 Mantenha objetos pontiagudos como tesouras, chaves ou facas longe. Isso pode causar cortes e / ou arranhões.
 Gardez les objets pointus comme des ciseaux, des clés ou des couteaux à distance. Ceux-ci peuvent provoquer des coupures et/ou des rayures.



No utilice papel periódico para brillar vidrios y/o espejos, esto los puede rayar. Es recomendable utilizar paños que no dejen pelusa.
 Do not use newspaper to shine glass and / or mirrors, this can scratch them. It is recommended to use lint-free cloths.
 Não use jornal para lusturar vidros e / ou espelhos, pois podem riscá-los. É aconselhável usar panos sem fiapos.
 N'utilisez pas de papier journal pour faire briller le verre et/ou les miroirs, cela peut les rayer. Il est conseillé d'utiliser des chiffons non pelucheux.

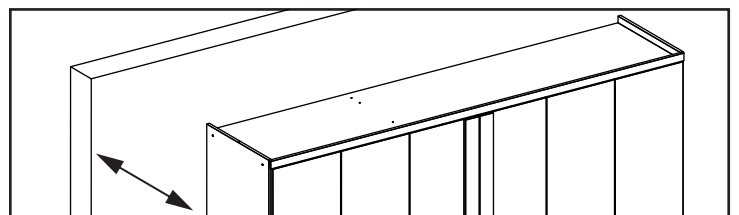

Se recomienda separar de la pared tus productos para que estos puedan tener una circulación de aire natural.



Evita que el agua entre en contacto con las partes de metal, ya que puede provocar manchas y óxido.
 Avoid getting water on metal parts as it can cause stains and rust.
 Evite molhar as peças de metal, pois pode causar manchas e ferrugem.
 Évitez de mettre de l'eau sur les pièces métalliques car cela peut causer des taches et de la rouille.

It is recommended to separate your products from the wall so that they can have a natural air circulation.
 Recomenda-se separar seus produtos da parede para que tenham uma circulação natural de ar.
 Il est recommandé de séparer vos produits du mur afin qu'ils puissent avoir une circulation d'air naturelle.

Consejos de Conservación y Pesos soportados

Conservation Tips and Supported Weights

Dicas de Conservação e Pesos Suportados

Conseils d'entretien et Poids Supportés

ES: 1. No debe utilizarse en la limpieza, abrasivos como lana de acero, alcohol, limón, o productos corrosivos que puedan rayar o quitar la película en los muebles.

2. Cuando la limpieza de muebles en general, napa y formica, deben utilizarse un paño ligeramente humedecido y jabón suave.
3. Para mover el mueble, es importante que este se eleve desde el suelo, debido a que el arrastre puede causar daño estructural.
4. No deje el mueble en exposición a la intemperie.

EN: 1. Do not use abrasive products to clean such as steel wool, alcohol, vinegar, lemon, scouring powder, or corrosive products which can scratch or peel off the protective film of the furniture.

2. The best way to clean your furniture is to use a slightly moistened cloth with a mild soap.
3. To move the furniture assembled, it is important that it is lifted off the ground, because the drag it can cause structural damage.
4. Do not leave your furniture in weather exposure.

PT: 1. Não utilizar na limpeza produtos abrasivos tais como: palha de aço, álcool, vinagre, limão, saponáceo ou produtos corrosivos que possam riscar ou descolar a película protetora dos móveis.

2. Na limpeza de móveis em geral, nappas e fórmicas, deve ser utilizado um pano levemente umedecido e sabão neutro.
3. Para a movimentação do móvel, é importante que este seja levantado do chão, pois ao arrastá-lo pode causar avarias estruturais.
4. Não deixe o móvel em exposição a intempéries.

FR: 1. Ne pas utiliser de produits abrasifs dans le nettoyage, tels que: laine d'acier, alcool, vinaigre, citron, poudre à récurer ou d'autres produits corrosifs pouvant rayer ou faire décoller la pellicule protectrice des meubles.

2. Pour le nettoyage du meuble, il est recommandé d'utiliser un chiffon humide et du savon neutre.
3. Pour déplacer le meuble, il est important de le soulever du sol car le tirer pourrait causer des dommages dans sa structure.
4. Ne pas exposer le meuble aux intempéries.

ES: Por favor, preste atención a los pesos máximos admitidos por cada compartimento del producto. Tenga cuidado de no exceder estos pesos, con el fin de garantizar la calidad y durabilidad del producto. Es importante recordar que los pesos muestran en caso de ser DISTRIBUIDA en toda el área de la plataforma.

EN: Please pay attention to the maximum weights supported by each compartment product. Be careful not to exceed these weights, in order to ensure the quality and durability of the product. It is important to remember also that the weights shown should be DISTRIBUTED throughout the area of the shelf.

PT: Por favor, preste atenção aos pesos máximos suportados por cada compartimento do produto. Cuide para não exceder esses pesos, afim de garantir a qualidade e a durabilidade do mesmo. É importante lembrar também que, os pesos mostrados devem ser DISTRIBUÍDOS ao longo de toda a área da peça.

FR: Veuillez faire attention aux poids maximums supportés par chaque compartiment du produit. Veillez à ne pas dépasser ces poids, afin de garantir la qualité et la durabilité du produit. Il est également important de vous rappeler que les poids indiqués doivent être RÉPARTIS sur toute la surface du rayon.

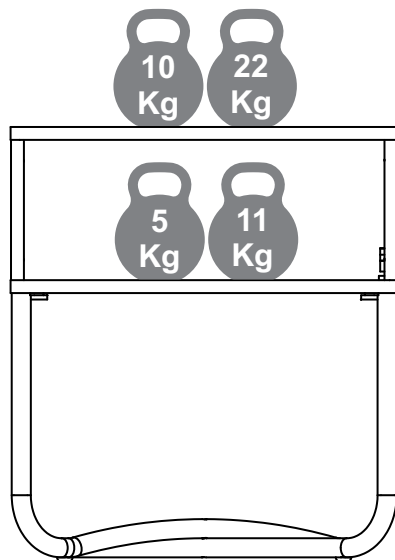



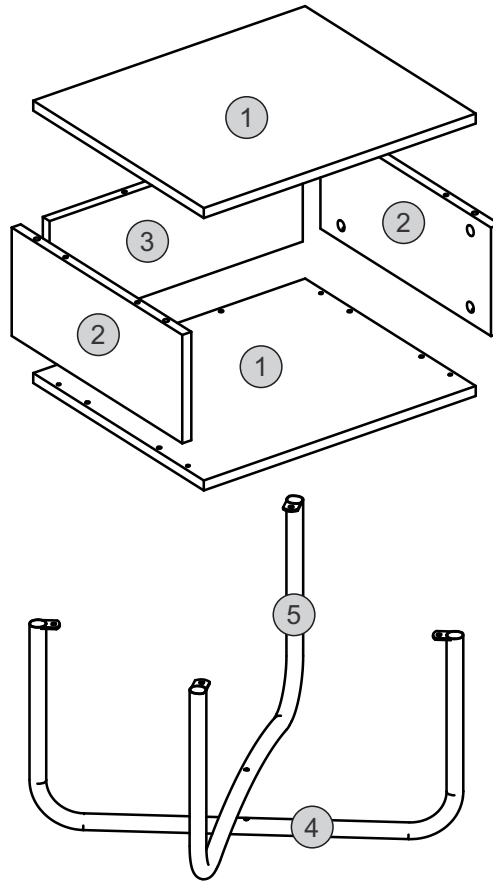





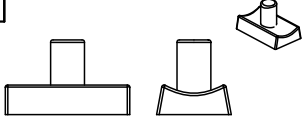

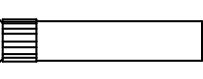

Conocer mejor las piezas de su producto 1
Getting to know your product parts better 1
Conhecendo melhor as peças do seu produto 1
Mieux connaître les pièces de votre produit 1

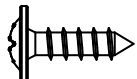
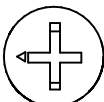
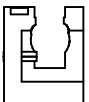

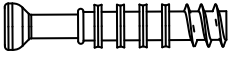
#	Ct. Qt.	Español	English	Português	Français	mm in
1	2	Base/Tapa	Base/Top Panel	Base/Tampo	Base/Partie Supérieure	450 x 380 x 15mm 17,72 x 14,96 x 0,59in
2	2	Lateral	Side	Lateral	Latéral	380 x 163 x 15mm 14,96 x 6,42 x 0,59in
3	1	Costado	Back	Costa	Pièce Arrière	419 x 163 x 15mm 16,50 x 6,42 x 0,59in
4	1	Pie Inferior	Bottom Foot	Pé Inferior	Pied Inférieur	578 x 308 x 23mm 22,76 x 12,13 x 0,91in
5	1	Pie Superior	Upper Foot	Pé Superior	Pied Supérieur	578 x 308 x 23mm 22,76 x 12,13 x 0,91in

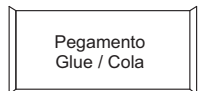
Y estos son sus Accesorios
And these are your Accessories
Estes são os seus Acessórios
ET voici vos Accessoires

<p>A</p>  <p>(4x)</p>	<p>B</p>   <p>Ø4x20mm/0,16x0,79in (1x)</p>	<p>C</p>   <p>Ø4x27mm/0,16x1,06in (1x)</p>	<p>D</p>   <p>Ø4x14mm/0,16x0,55in (4x)</p>
<p>E</p>   <p>(8x)</p>	<p>F</p>   <p>(8x)</p>	<p>G</p>  <p>Ø6x30mm/0,24x1,18in (12x)</p>	<p>H</p>  <p>(1x)</p>
<p>I</p>  <p>(8x)</p>			

Y si lo necesitas, mide en la regla al lado
And if you need to, measure on the ruler beside
E se precisar, meça na régua ao lado
ET si vous en avez besoin, mesurez sur la règle à côté

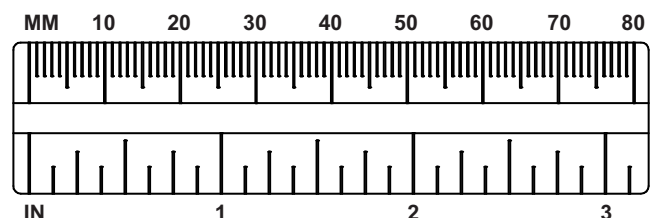

Y aquí, algunos Consejos de Montaje
And here, some Assembly Tips
Eaqui, algumas Dicas de Montagem
ET ici, quelques Conseils de Montage

**CONSEJOS DE MONTAJE PARA EL SISTEMA MINIFIX / TIPS FOR FITTINGS CAM-LOCKS
 DICAS DE MONTAGEM DO SISTEMA MINIFIX / CONSEILS D'ASSEMBLAGE DU SYSTÈME MINIFIX**

TAMBOR DEL MINIFIX / CAM NUT / TAMBOR MINIFIX / TAMBOUR MINIFIX

ES: AL MONTAR EL TAMBOR DEL MINIFIX, ASEGÚRESE DE QUE LA POSICIÓN INICIAL ES CORRECTA, ANTES DE INSERTAR EL TORNILLO DEL MINIFIX, Y GIRE EN EL SENTIDO DE LAS AGUJAS DEL RELOJ HASTA QUE QUEDE ASEGURADO.

EN: WHEN FITTING CAM NUT, ENSURE STARTING POSITION IS CORRECT BEFORE YOU INSERT CONNECTING CAM BOLT TURN CLOCKWISE UNTIL SECURE

PT: AO ENCAIXAR O TAMBOR MINIFIX, CERTIFIQUE-SE DE QUE A POSIÇÃO INICIAL ESTEJA CORRETA, ANTES DE INSERIR NO PARAFUSO MINIFIX, E GIRE NO SENTIDO HORÁRIO ATÉ FIXAR.

FR: LORS DU MONTAGE DU TAMBOUR MINIFIX, ASSUREZ-VOUS QUE LA POSITION INITIALE EST CORRECTE, AVANT D'INSÉRER LA VIS MINIFIX, ET TOURNEZ DANS LE SENS DES AIGUILLES D'UNE MONTRE JUSQU'À CE QU'ELLE SOIT FIXÉE.

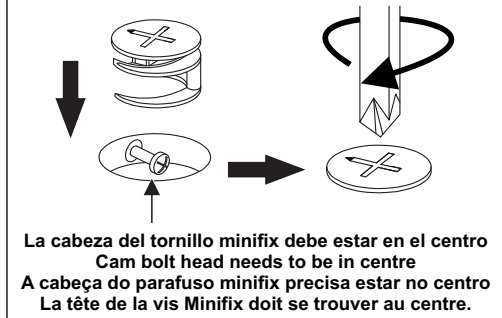
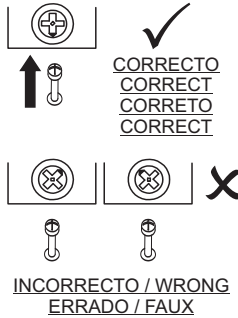

TORNILLO DEL MINIFIX / CAMBOLT / PARAFUSO MINIFIX / VIS MINIFIX

ES: APRIETE HASTA QUE LA VARILLA QUEDE A RAS DEL PANEL. NO APRIETE EN EXCESO NI EN DEFECTO (VÉANSE LOS EJEMPLOS AL LADO).

EN: TIGHTEN UNTIL SHOULDER IN FLUSH WITH PANEL. DO NOT OVERTIGHTEN OR UNDERTIGHTEN (SEE EXAMPLES BESIDE).

PT: APERTAR ATÉ A HASTE NIVELAR COM O PAINEL. NÃO APERTAR DEMAIS OU APERTAR POUCO (VER EXEMPLOS AO LADO).

FR: SERREZ JUSQU'À CE QUE LA TIGE SOIT AU MÊME NIVEAU QUE LE PANNEAU. NE SERREZ PAS TROP OU PASASSEZ (VOIR EXEMPLES CI-CONTRE).

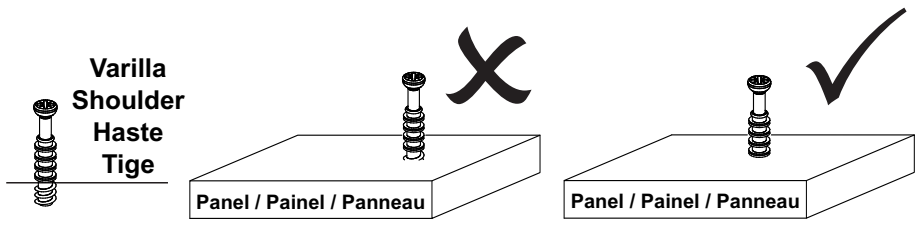

HERRAMIENTAS NECESARIAS / TOOLS REQUIRED / FERRAMENTAS NECESSÁRIAS / OUTILS NÉCESSAIRES

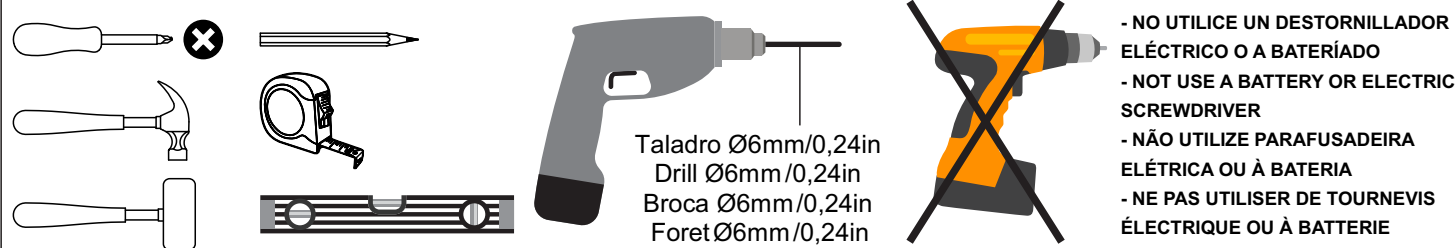

NÚMERO DE PERSONAS Y ÁREA DE ARMADO

NUMBER OF PEOPLE AND ASSEMBLY AREA

NÚMERO DE PESSOAS E ÁREA DE MONTAGEM

NOMBRE DE PERSONNES ET ZONE DE RASSEMBLEMENT

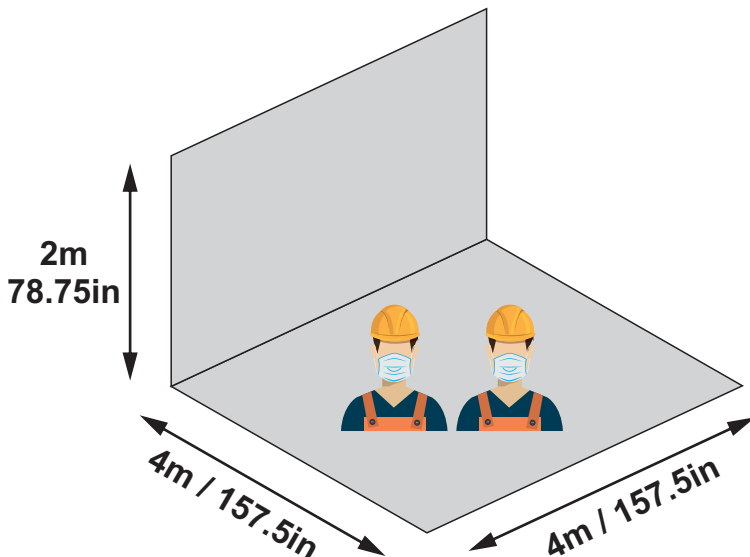

ÁREA GRIS / GRAY AREA / ÁREA CINZA / ZONE GRISE

ES: LAS ÁREAS MARCADAS CON COLOR GRIS SIGNIFICAN QUE ESTA PARTE DE LA PIEZA NO TIENE ACABADO, COMO LOS EJEMPLOS DE ABAJO.

EN: THE AREAS MARKED WITH THE COLOR GRAY MEAN THAT THIS PART OF THE PART IS NOT FINISHED, AS PER EXAMPLES BELOW.

PT: AS ÁREAS MARCADAS COM A COR CINZA SIGNIFICAM QUE ESSA PARTE DA PEÇA NÃO POSSUI ACABAMENTO, CONFORME EXEMPLOS ABAIXO.

FR: LES ZONES MARQUÉES D'UNE COULEUR GRISE SIGNIFIENT QUE CETTE PARTIE DE LA PIÈCE N'A PAS DE FINITION, COMME LES EXEMPLES CI-DESSOUS.

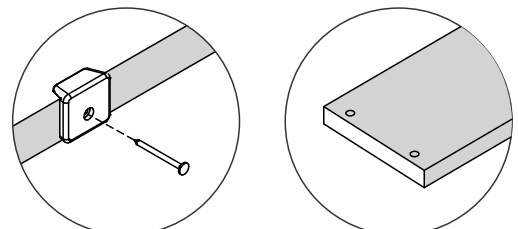



1

PIEZAS NECESARIAS
PARTS REQUIRED
PEÇAS NECESSÁRIAS
PIÈCES NÉCESSAIRES

2 x2 **3** x1

ACCESORIOS NECESARIOS
HARDWARE REQUIRED
ACESSÓRIOS NECESSÁRIOS
ACCESSOIRES NÉCESSAIRES

G  12x
Ø6x30mm/0,24x1,18in

H  1x

HERRAMIENTAS NECESARIAS
TOOLS REQUIRED
FERRAMENTAS NECESSÁRIAS
OUTILS NÉCESSAIRES

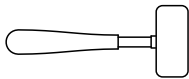

Detalle 1 / Detail 1
Detalhe 1 / Détail 1

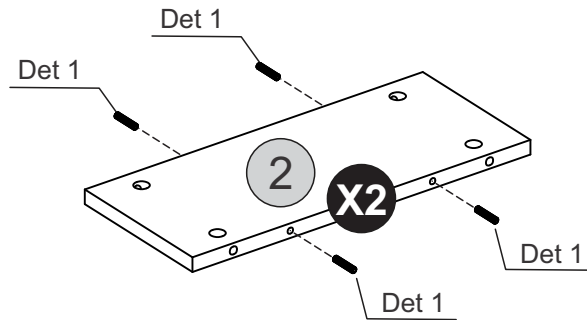
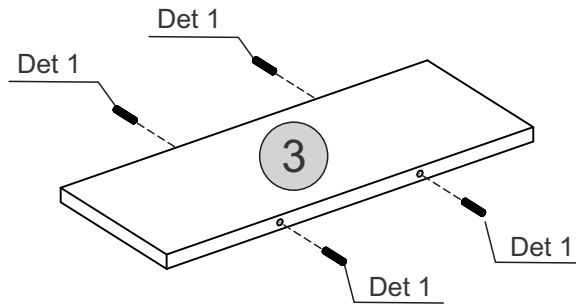

2

PIEZAS NECESARIAS
PARTS REQUIRED
PEÇAS NECESSÁRIAS
PIÈCES NÉCESSAIRES

1 x2

ACCESORIOS NECESARIOS
HARDWARE REQUIRED
ACESSÓRIOS NECESSÁRIOS
ACCESSOIRES NÉCESSAIRES

F  8x

HERRAMIENTAS NECESARIAS
TOOLS REQUIRED
FERRAMENTAS NECESSÁRIAS
OUTILS NÉCESSAIRES

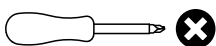

Detalle 2 / Detail 2
Detalhe 2 / Détail 2

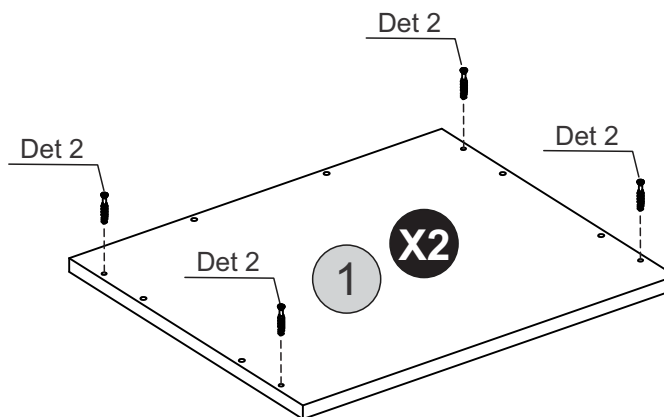
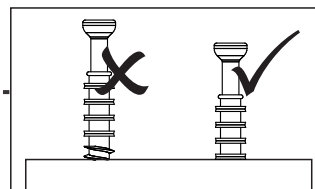
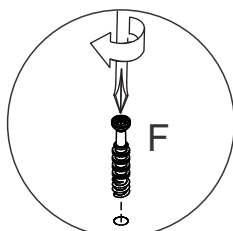

3

PIEZAS NECESARIAS
PARTS REQUIRED
PEÇAS NECESSÁRIAS
PIÈCES NÉCESSAIRES

1	x1	2	x2
---	----	---	----

ACCESORIOS NECESARIOS
HARDWARE REQUIRED
ACESSÓRIOS NECESSÁRIOS
ACCESSOIRES NÉCESSAIRES

E		4x
---	---	----

I		4x
---	---	----

HERRAMIENTAS NECESARIAS
TOOLS REQUIRED
FERRAMENTAS NECESSÁRIAS
OUTILS NÉCESSAIRES

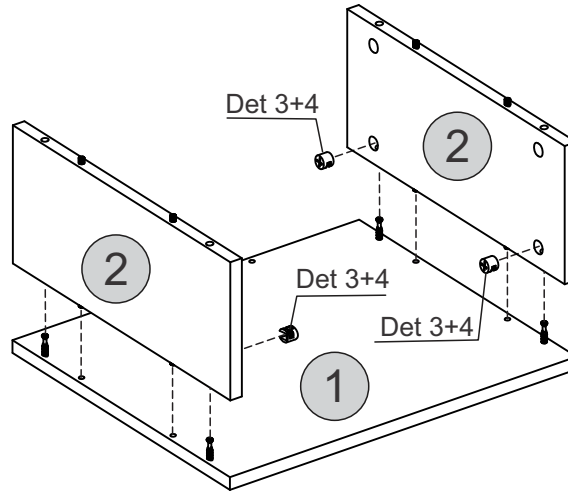
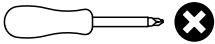

Detalle 3 / Detail 3
Detalhe 3 / Détail 3

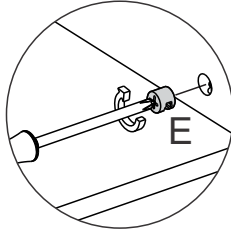

Detalle 4 / Detail 4
Detalhe 4 / Détail 4

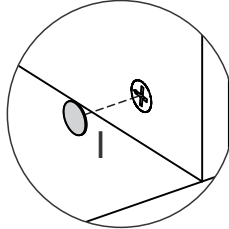

4

PIEZAS NECESARIAS
PARTS REQUIRED
PEÇAS NECESSÁRIAS
PIÈCES NÉCESSAIRES

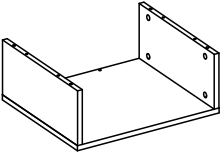

3	x1
---	----

ACCESORIOS NECESARIOS
HARDWARE REQUIRED
ACESSÓRIOS NECESSÁRIOS
ACCESSOIRES NÉCESSAIRES

H		1x
---	---	----

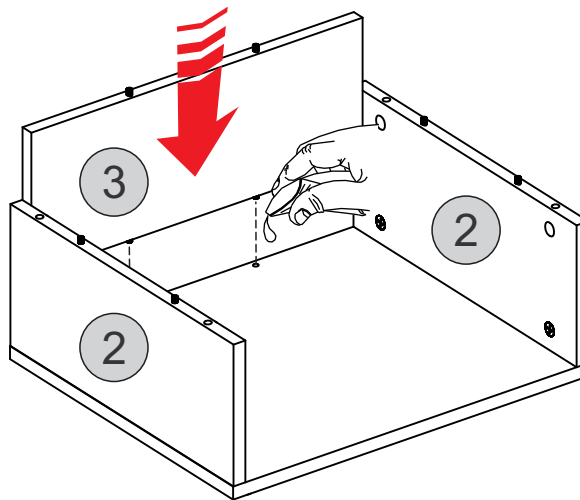

5

PIEZAS NECESARIAS
PARTS REQUIRED
PEÇAS NECESSÁRIAS
PIÈCES NÉCESSAIRES

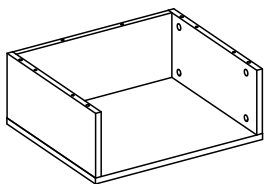

1 x1

ACCESORIOS NECESARIOS
HARDWARE REQUIRED
ACESSÓRIOS NECESSÁRIOS
ACCESSOIRES NÉCESSAIRES

E   4x

I  4x

HERRAMIENTAS NECESARIAS
TOOLS REQUIRED
FERRAMENTAS NECESSÁRIAS
OUTILS NÉCESSAIRES

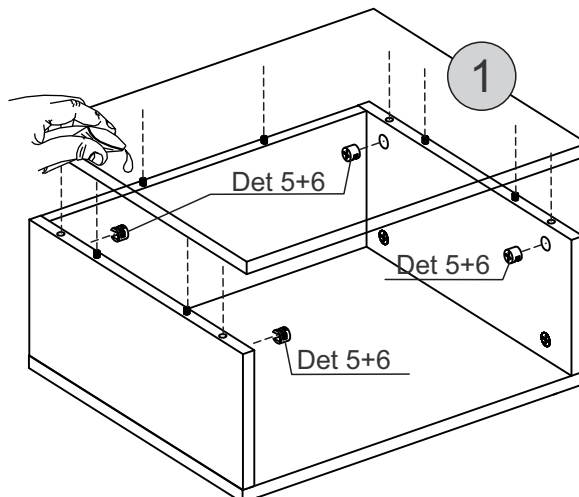
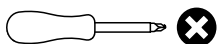

Detalle 5 / Detail 5
Detalhe 5/ Détail 5

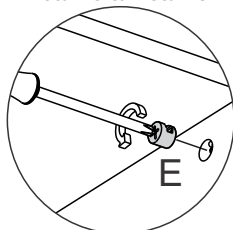

Detalle 6 / Detail 6
Detalhe 6/ Détail 6

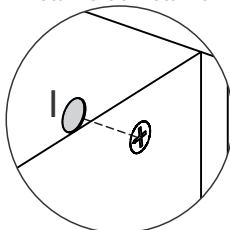

6

PIEZAS NECESARIAS
PARTS REQUIRED
PEÇAS NECESSÁRIAS
PIÈCES NÉCESSAIRES

4 x1 5 x1

ACCESORIOS NECESARIOS
HARDWARE REQUIRED
ACESSÓRIOS NECESSÁRIOS
ACCESSOIRES NÉCESSAIRES

A  4x

HERRAMIENTAS NECESARIAS
TOOLS REQUIRED
FERRAMENTAS NECESSÁRIAS
OUTILS NÉCESSAIRES

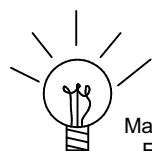
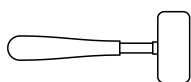

CONSEJO (para todos los pasos) / TIP (for all steps)
DICA (para todos os passos) / CONSEIL (pour toutes les étapes)

Realizar el montaje en una superficie suave, que no dañe los muebles o el piso de su casa.
Make the assembly on a soft surface, which does not damage the furniture or the floor of your home.
Efetue a montagem sobre superfície macia, que não danifica o móvel e nem o piso de sua casa.
Montez-le sur une surface douce, qui n'endommage pas les meubles ou le sol de votre maison.

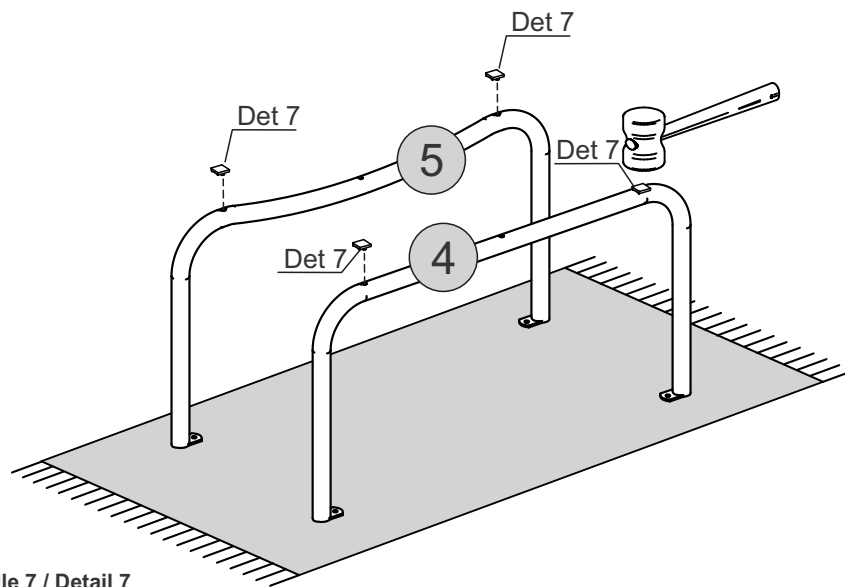

Detalle 7 / Detail 7
Detalhe 7 / Détail 7

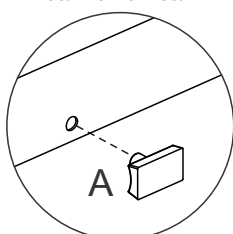





7

PIEZAS NECESARIAS
PARTS REQUIRED
PEÇAS NECESSÁRIAS
PIÈCES NÉCESSAIRES

4 x1 **5** x1

ACCESORIOS NECESARIOS
HARDWARE REQUIRED
ACESSÓRIOS NECESSÁRIOS
ACCESSOIRES NÉCESSAIRES

B   1x
Ø4x20mm/0,16x0,79in

C   1x
Ø4x27mm/0,16x1,06in

HERRAMIENTAS NECESARIAS
TOOLS REQUIRED
FERRAMENTAS NECESSÁRIAS
OUTILS NÉCESSAIRES

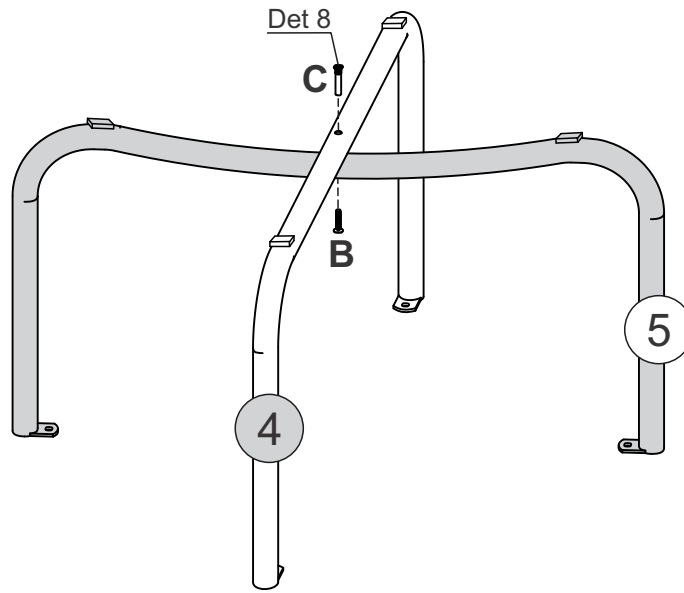
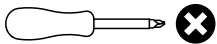

Detalle 8 / Detail 8
Detalhe 8 / Détail 8

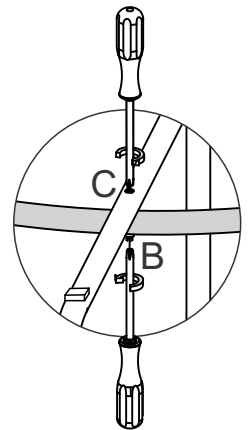

8

PIEZAS NECESARIAS
PARTS REQUIRED
PEÇAS NECESSÁRIAS
PIÈCES NÉCESSAIRES

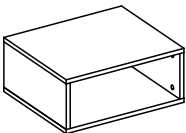
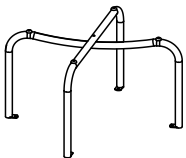

ACCESORIOS NECESARIOS
HARDWARE REQUIRED
ACESSÓRIOS NECESSÁRIOS
ACCESSOIRES NÉCESSAIRES

D   4x
Ø4x14mm/0,16x0,55in

HERRAMIENTAS NECESARIAS
TOOLS REQUIRED
FERRAMENTAS NECESSÁRIAS
OUTILS NÉCESSAIRES

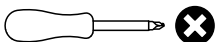

Alineación / Alignment
Alinhamento / Alinhement

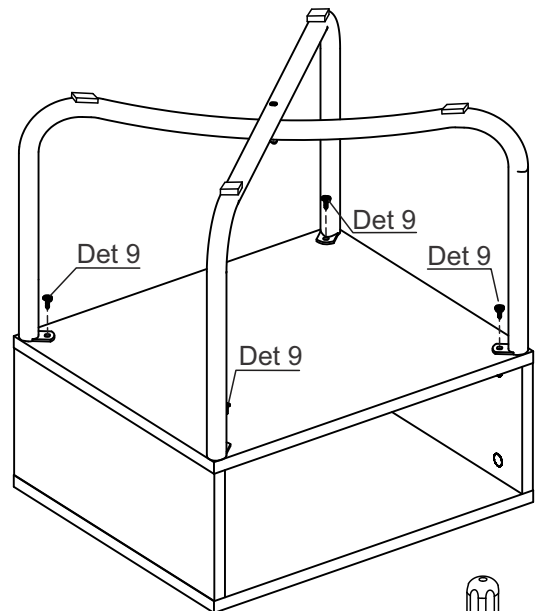
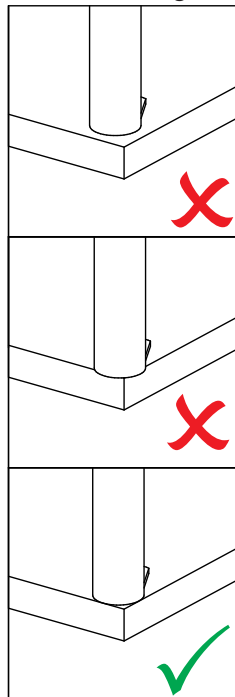

Detalle 9 / Detail 9
Detalhe 9 / Détail 9

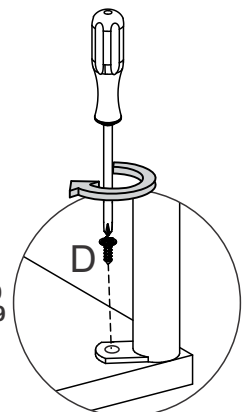

Al fijar, observe la alineación correcta entre los tubos y la tapa superior.
When fixing, observe the correct alignment between the tubes and the top panel.
Ao fixar, observe o correto alinhamento entre os tubos e o tampo.
Lors de la fixation, observez le bon alignement entre les tubes et la partie supérieure.